

DESCRIPCION TECNICA

PRODUCTO	MATERIAL	ESPESOR (mm)	P E S O (kg/m <sup>2</sup> )	RENDIMIENTO (Paneles/m <sup>2</sup> )
CIELO VERTICAL 100V	ALUZINC	0,4	3,55	10
CIELO VERTICAL 200V		0,5	8,44	5

OPCIONES REMATE CONTRA MURO CANTERIA

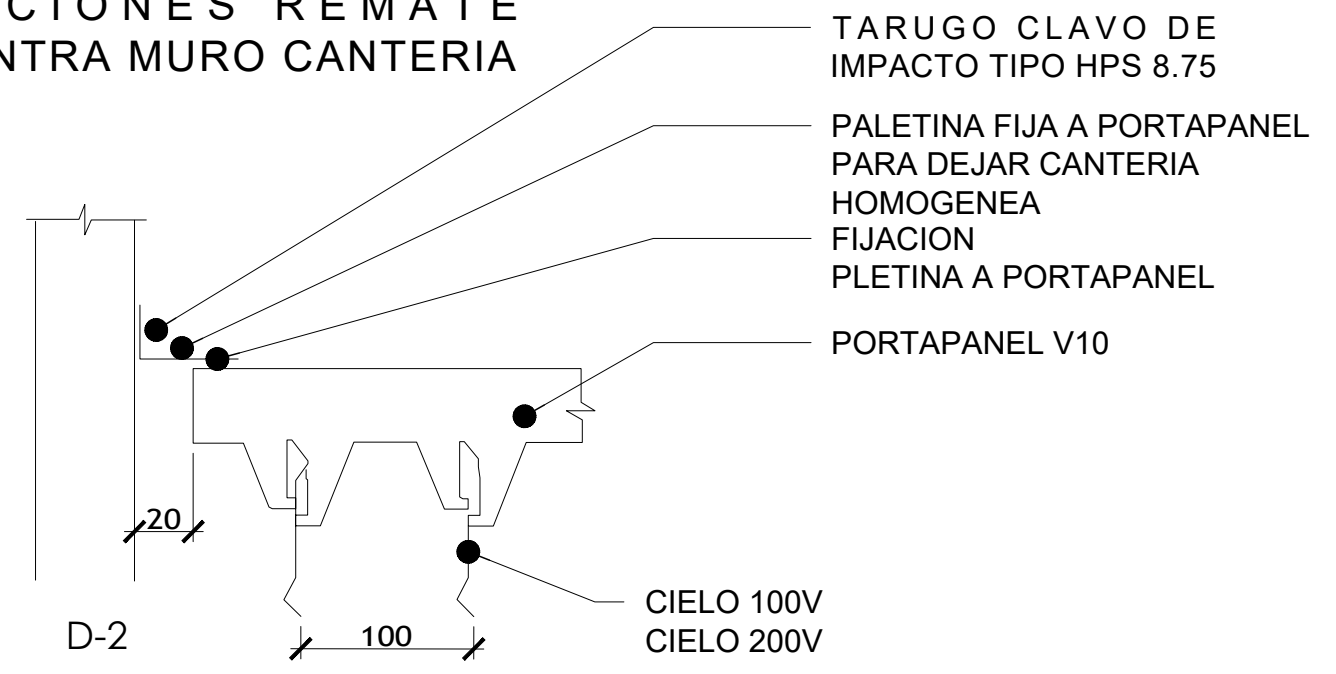

DETALLE ANGULO DE GIRO

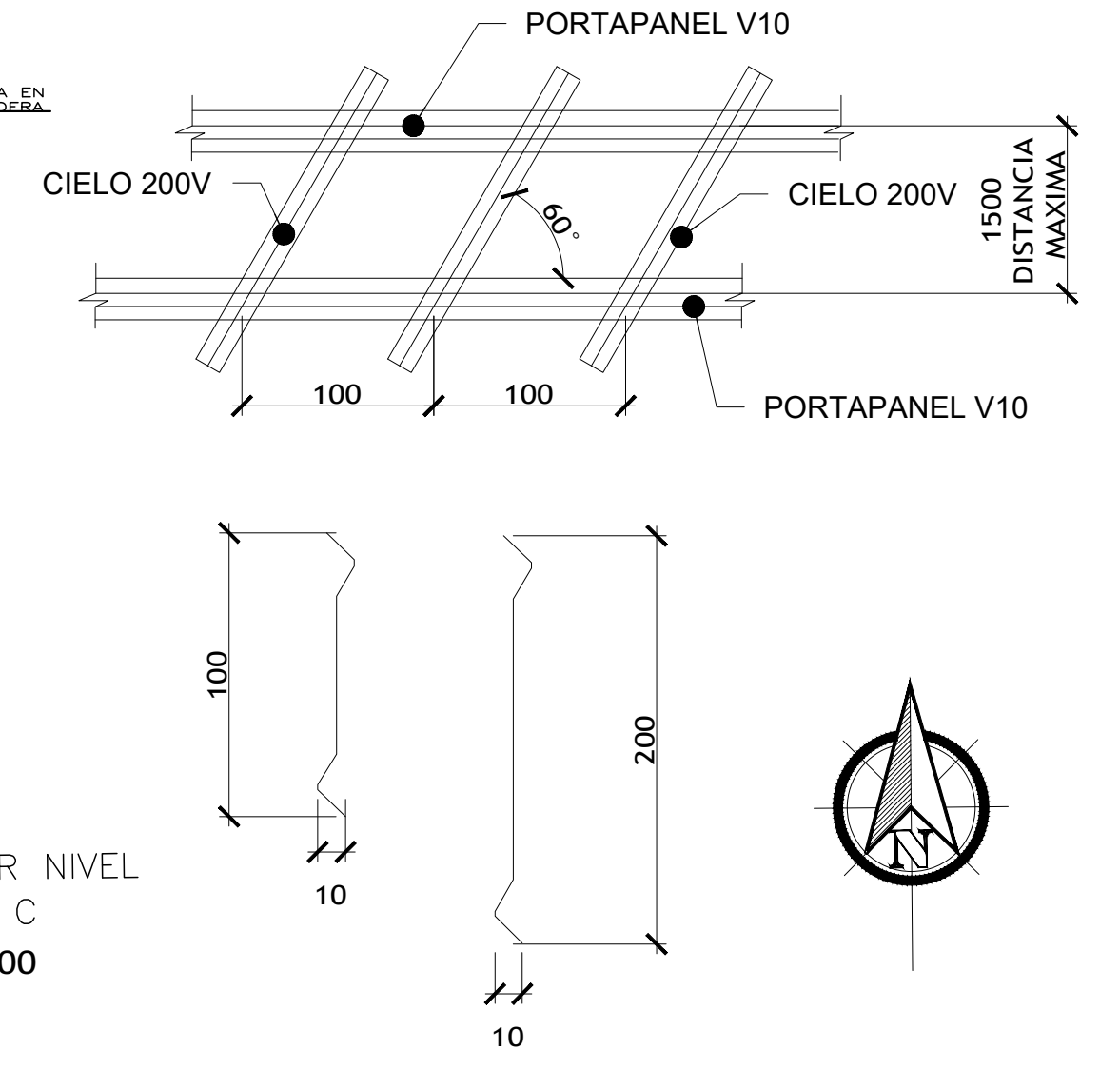

DETALLE DE PLAFÓN Y MURO SISTEMA DE UNIÓN

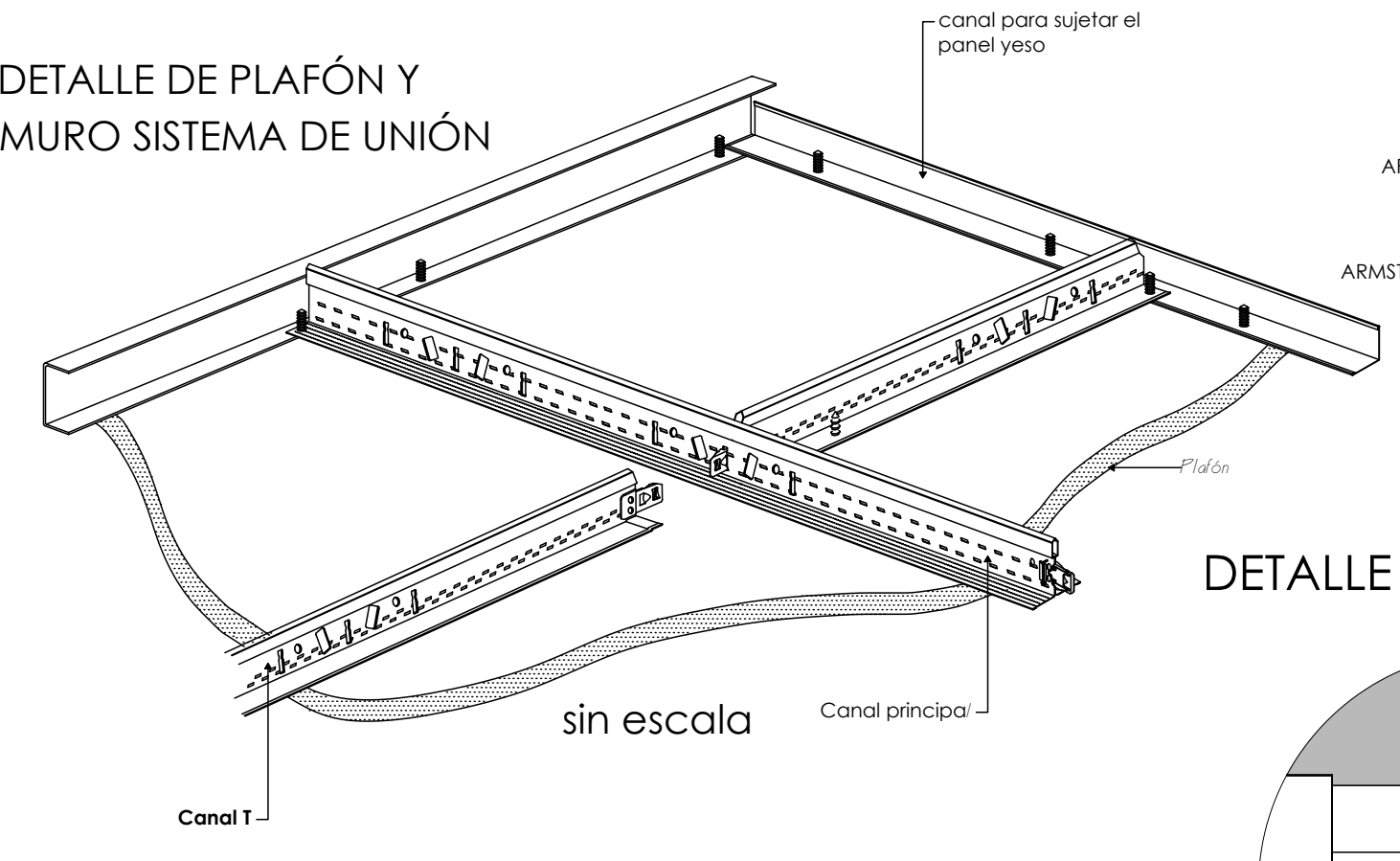

DETALLE D-3

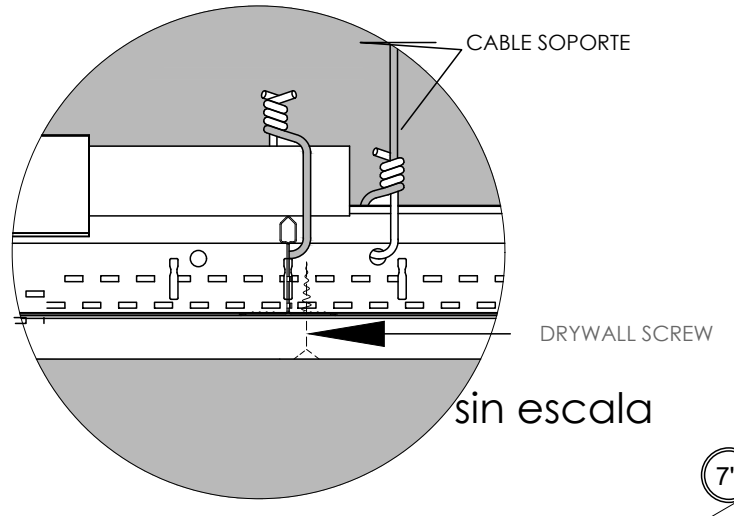

DETALLE DE SUJETACION DE LUMINARIA A PLAFON METALICO

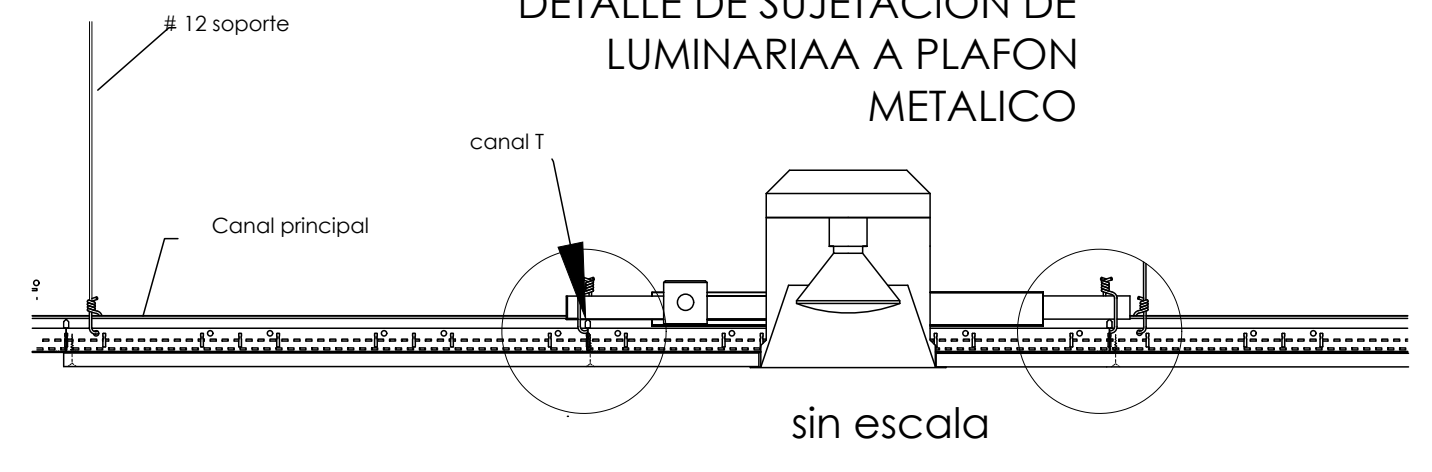

PLANTA PRIMER NIVEL SECTOR C ESC. 1/100

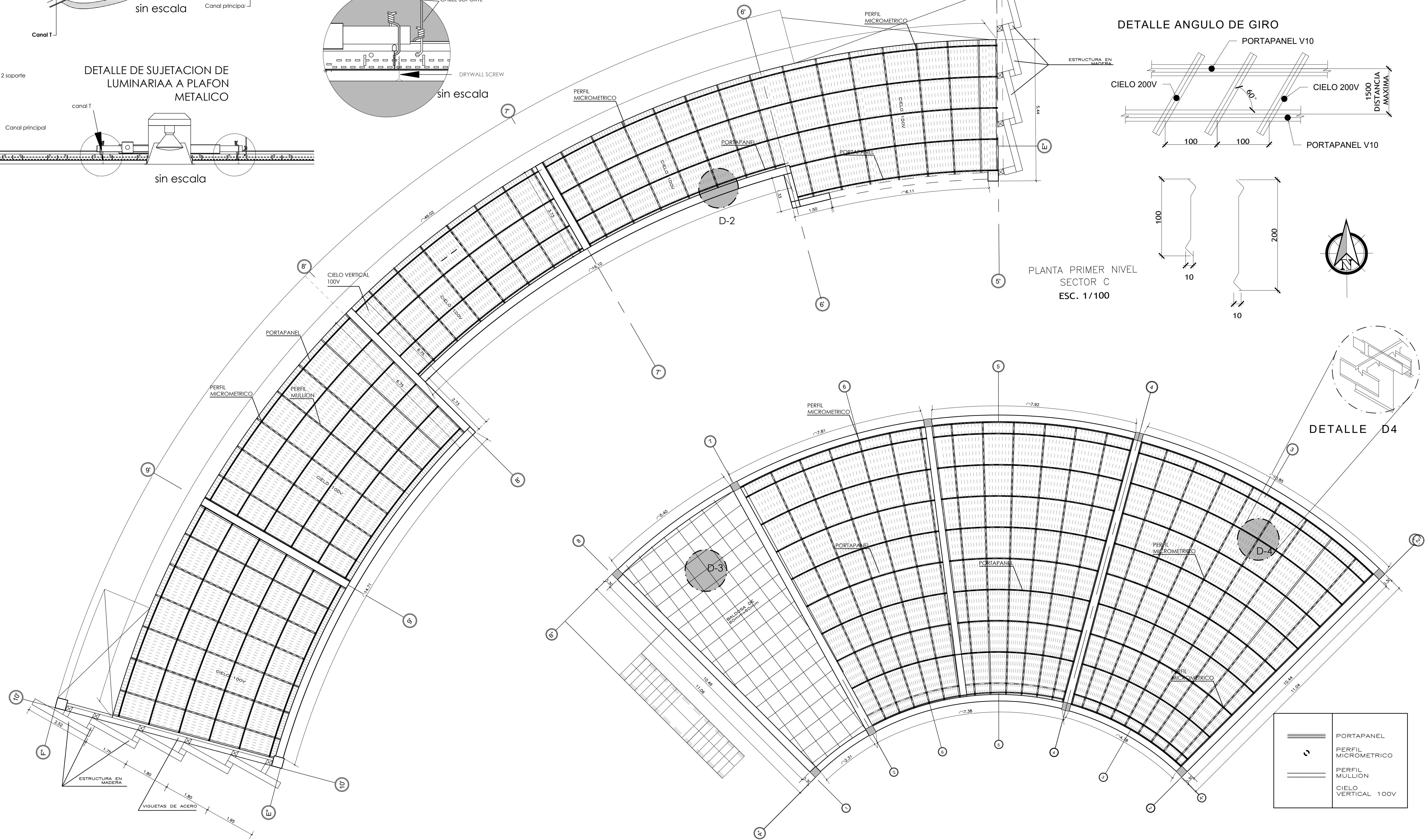

	PORTAPANEL
	PERFIL MICROMETRICO
	PERFIL MULLION
	CIELO VERTICAL 100V

SEGUNDO NIVEL - SALAS DE INTERPRETACIÓN Y OFICINAS



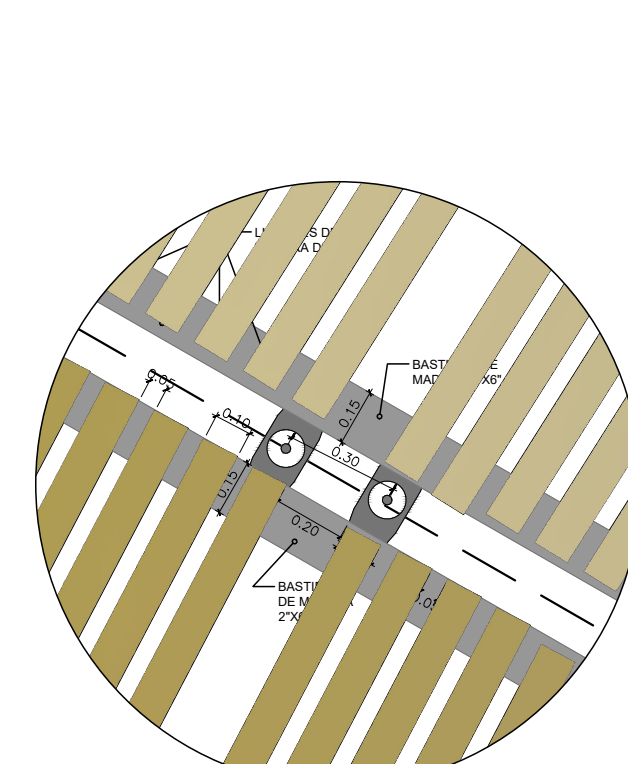
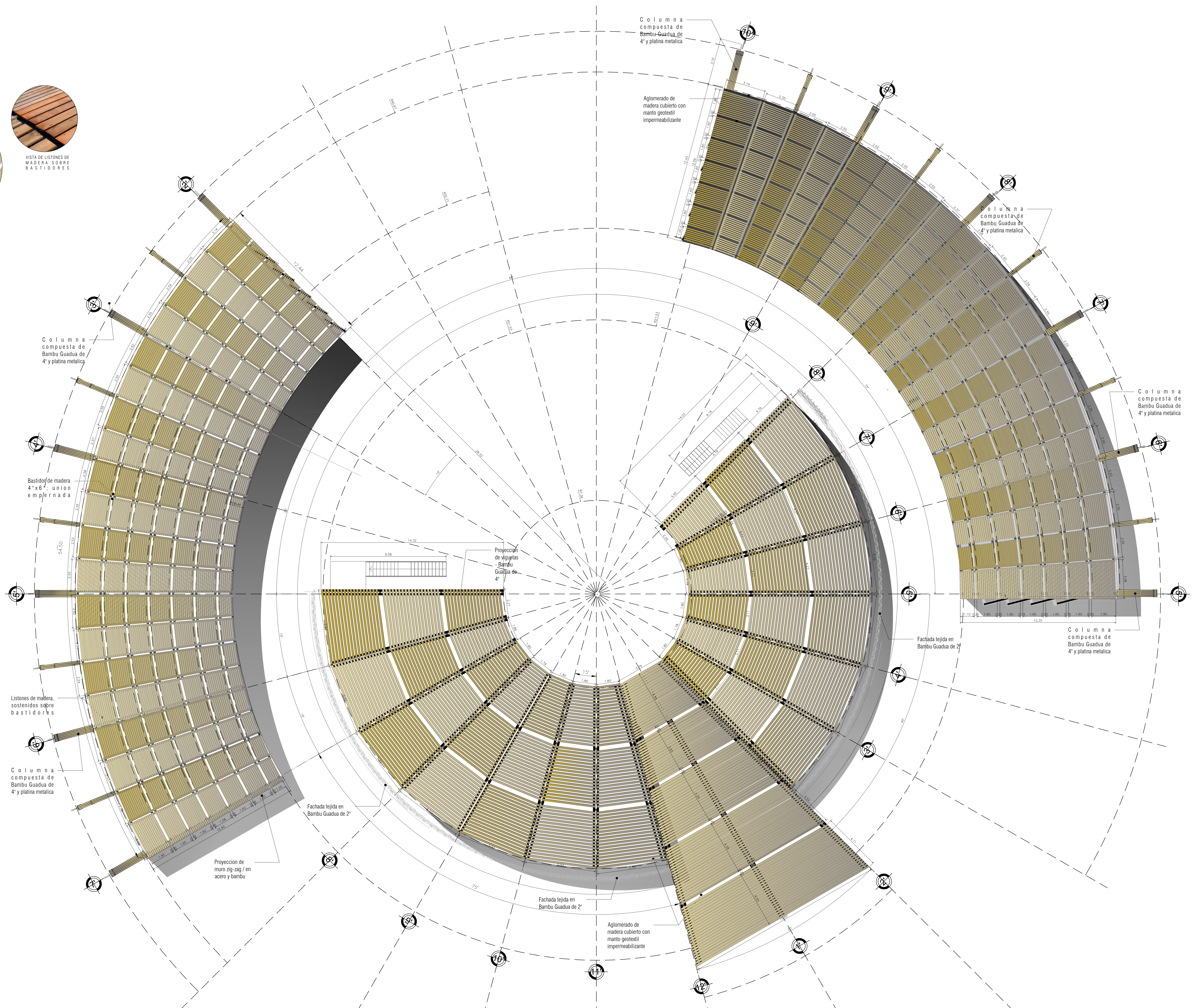
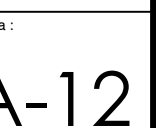
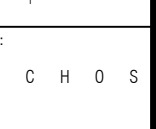
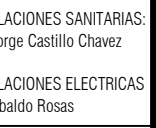
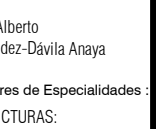
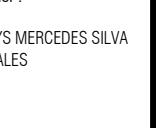
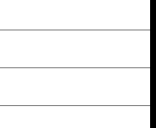
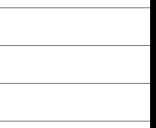
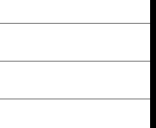
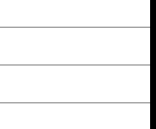
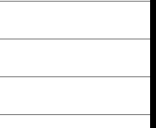
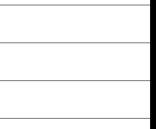
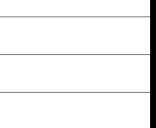
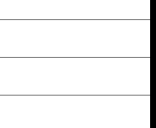
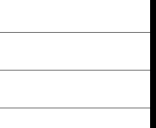
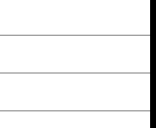
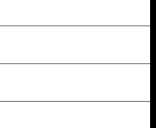
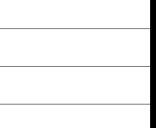
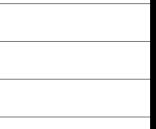
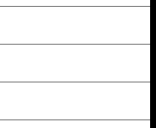
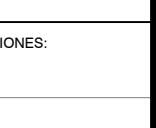
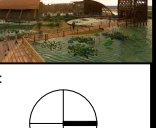
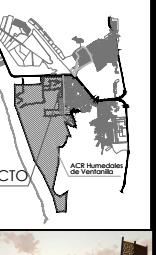
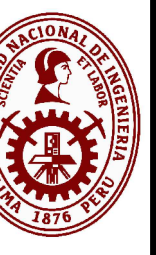

VISTA DE LISTONES DE MADERA SOBRE BASTIDORES



VISTA DE BASTIDORES UNIDOS MEDIANTE UNION METALICA

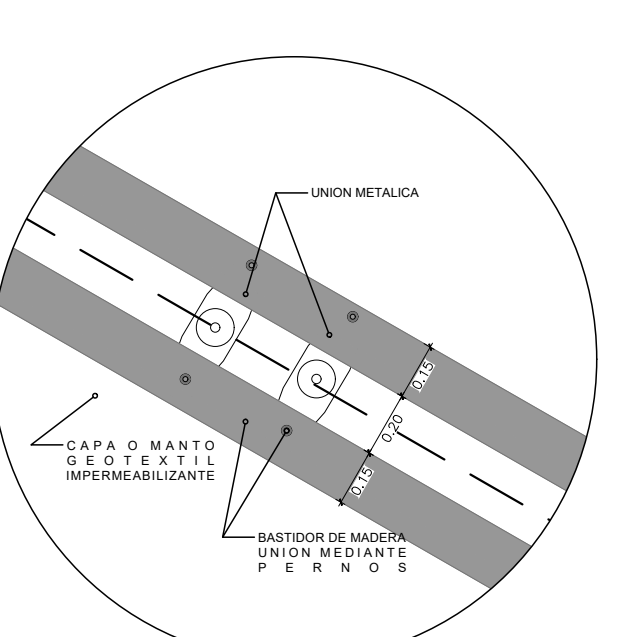

Columna compuesta de Bambu Guadua de 4" y platina metalica



VISTA DE BASTIDORES SOBRE MANTO GEOTEXTIL

Listones de madera, sostenidos sobre bastidores

Columna compuesta de Bambu Guadua de 4" y platina metalica

Fachada tejida en Bambu Guadua de 2"

Proyeccion de muro zig-zag / en acero y bambu

Fachada tejida en Bambu Guadua de 2"

Aglomerado de madera cubierto con manto geotextil impermeabilizante

Columna compuesta de Bambu Guadua de 4" y platina metalica

Aglomerado de madera cubierto con manto geotextil impermeabilizante

Columna compuesta de Bambu Guadua de 4" y platina metalica

Columna compuesta de Bambu Guadua de 4" y platina metalica

Columna compuesta de Bambu Guadua de 4" y platina metalica

Fachada tejida en Bambu Guadua de 2"

Columna compuesta de Bambu Guadua de 4" y platina metalica



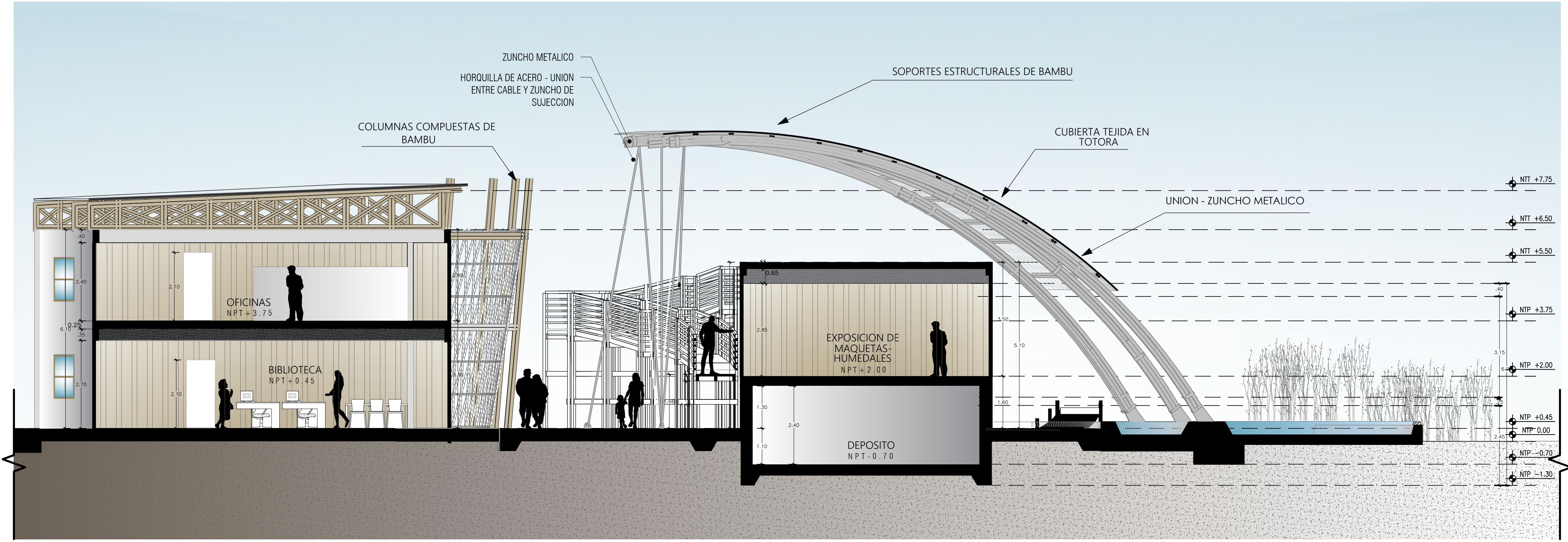
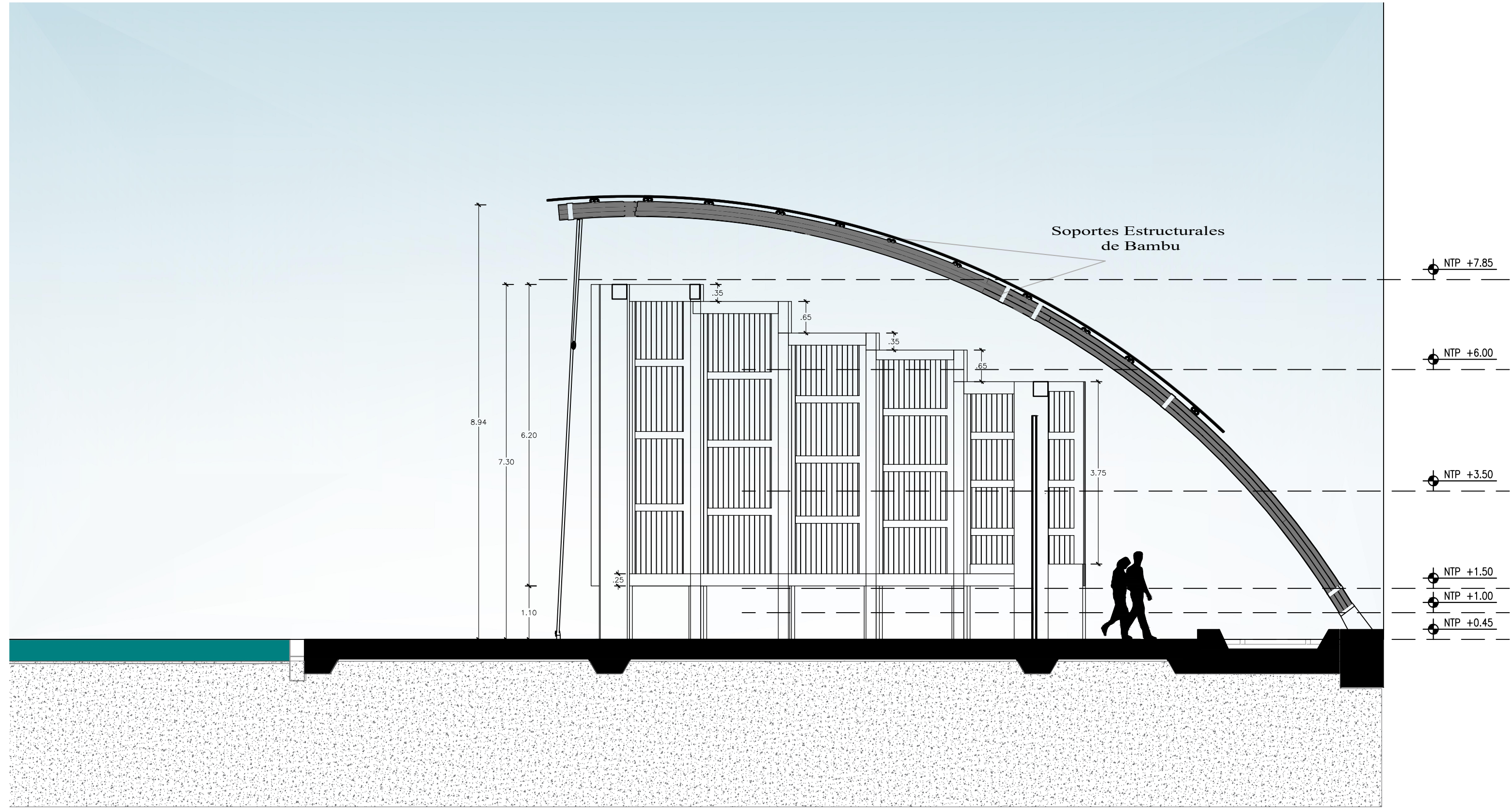

CORTE A - A

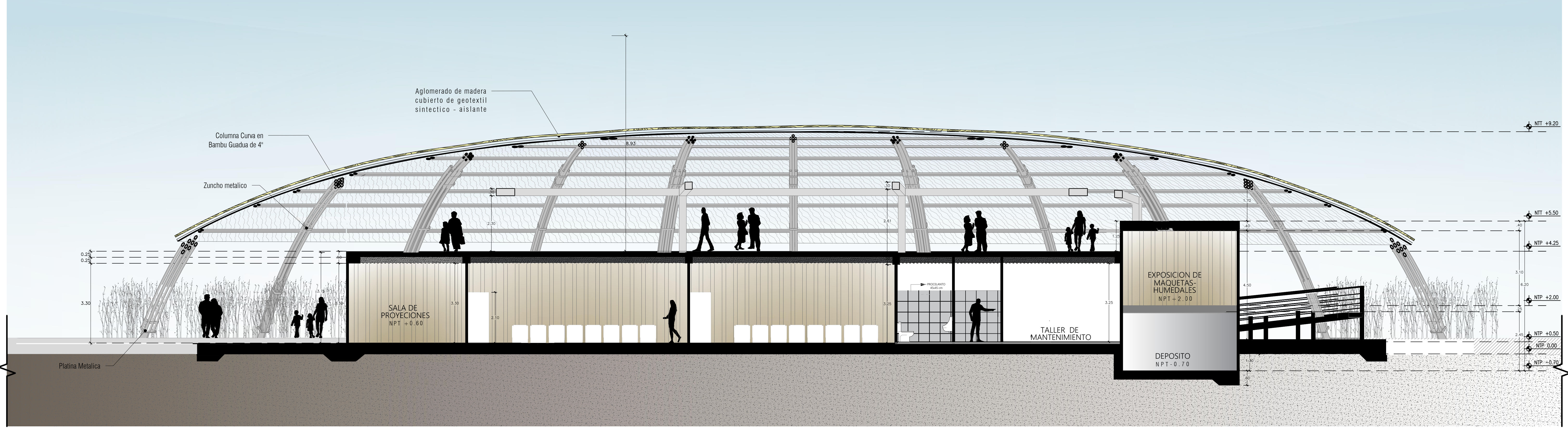

CORTE B - B

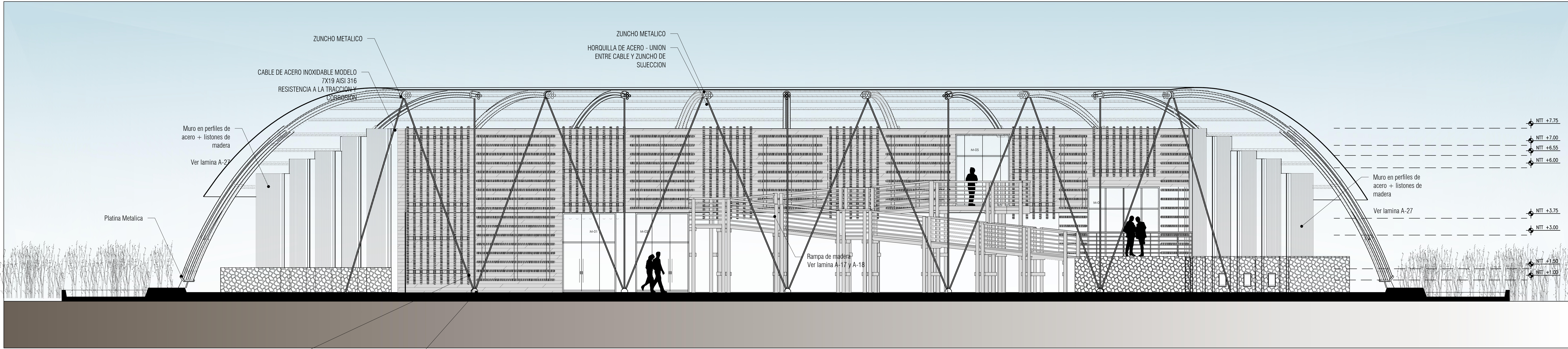

ELEVACION E-01 / SECTOR INTERPRETACION







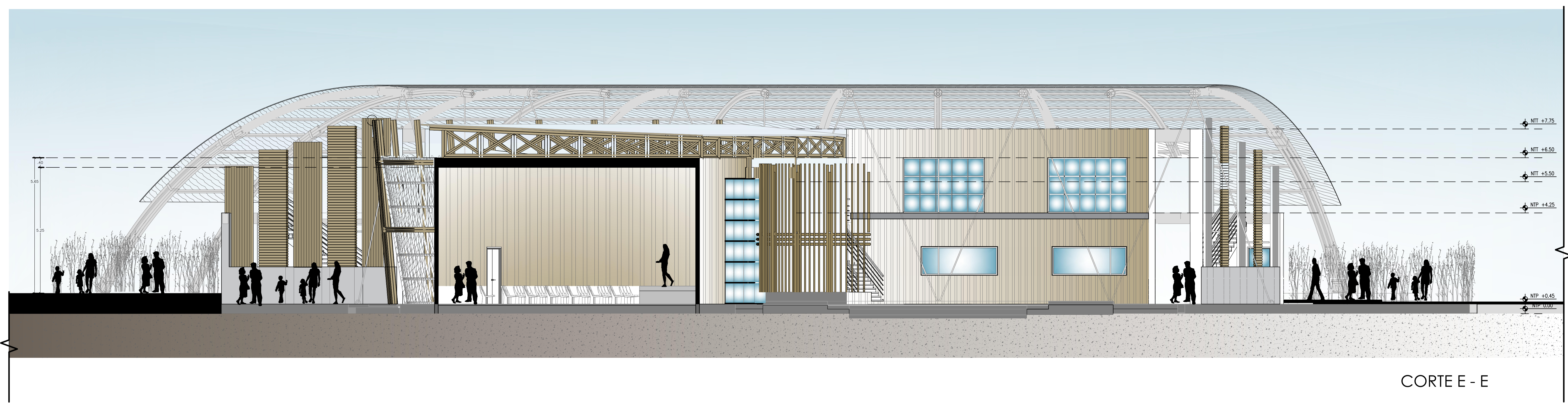

CORTE E - E

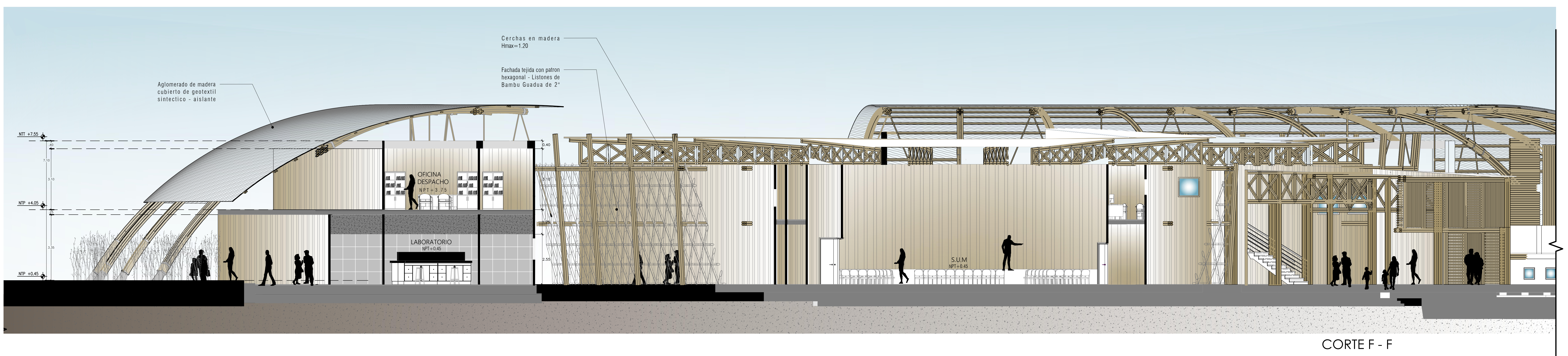

CORTE F - F

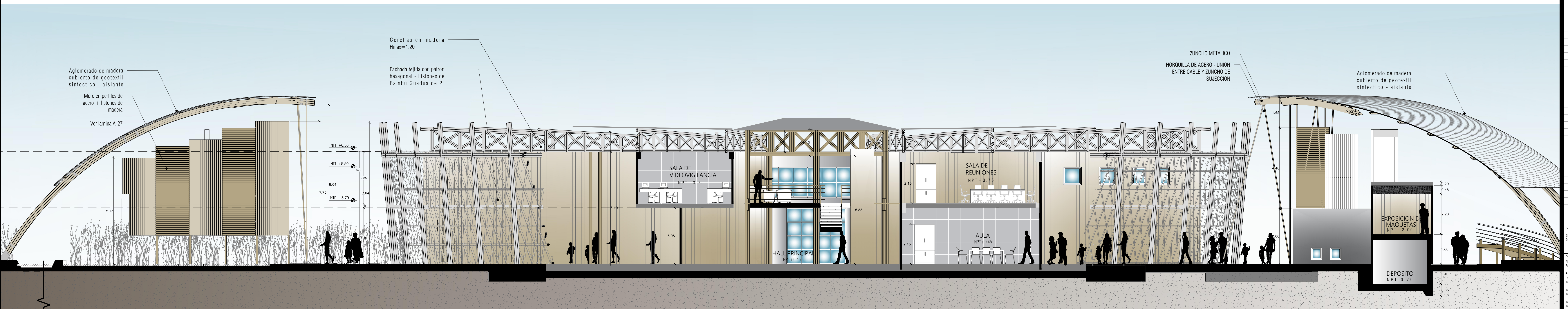

CORTE G - G



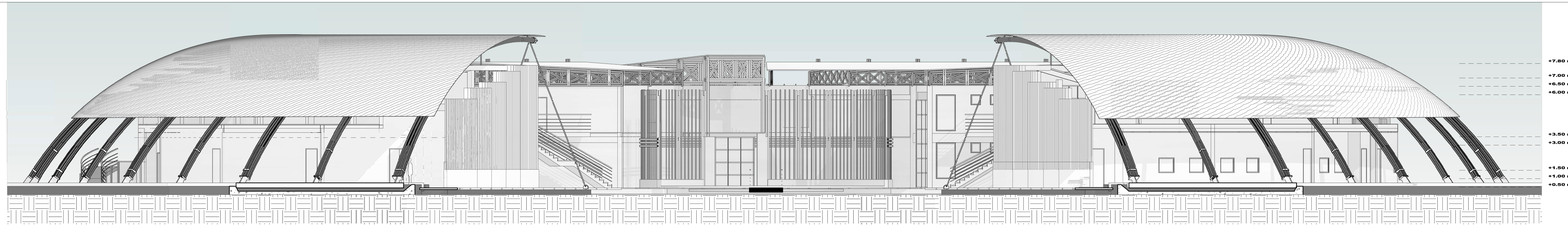

E L E V A C I O N E 1

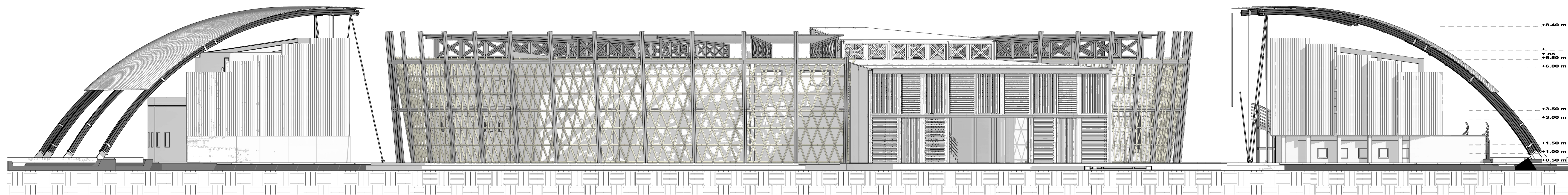

E L E V A C I O N E 2

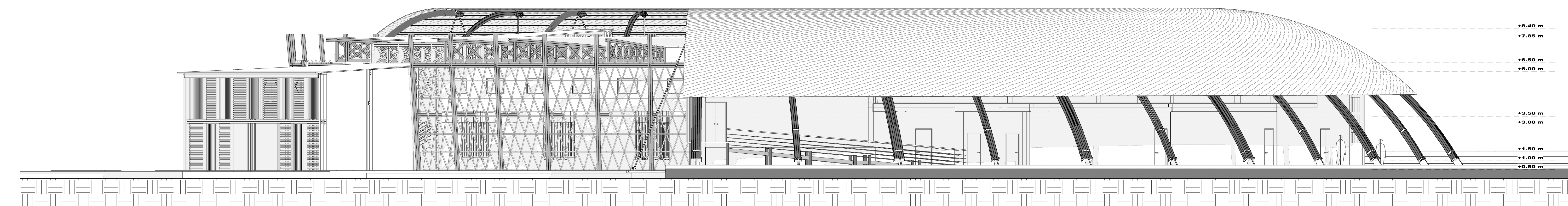

E L E V A C I O N E 3

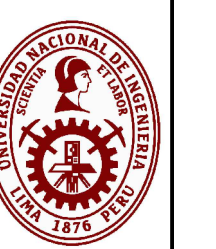

UNIVERSIDAD  
NACIONAL  
DE  
INGENIERIA



FACULTAD DE  
ARQUITECTURA,  
URBANISMO Y  
ARTES

PROYECTO :  
CENTRO DE  
INTERPRETACION  
E  
INVESTIGACION  
EN EL AREA  
DE  
CONSERVACION  
REGIONAL  
HUMEDALES  
DE  
VENTANILLA

AREA DE  
CONSERVACION  
REGIONAL  
HUMEDALES DE  
VENTANILLA

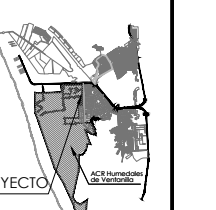

UBICACION

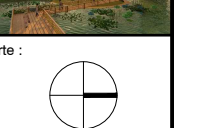

REVISIONES

NO.

FECHA

REVISIONES

NO.

FECHA

REVISIONES

NO.

FECHA

REVISIONES

NO.

FECHA

REVISIONES

NO.

FECHA

REVISIONES

NO.

FECHA

REVISIONES

NO.

FECHA

REVISIONES

NO.

FECHA

REVISIONES

NO.

FECHA

REVISIONES

NO.

FECHA

REVISIONES

NO.

FECHA

REVISIONES

NO.

FECHA



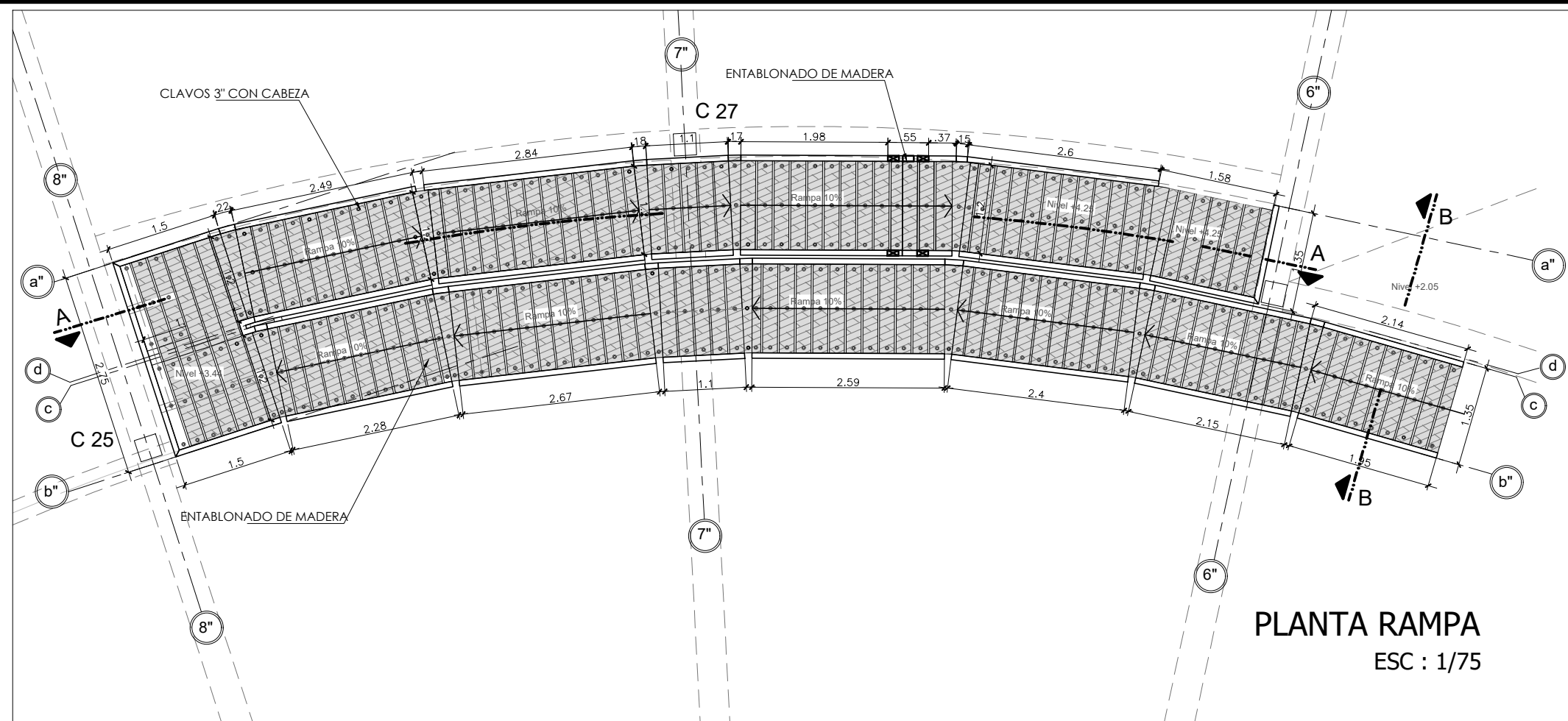

PLANTA RAMPA  
ESC : 1/75

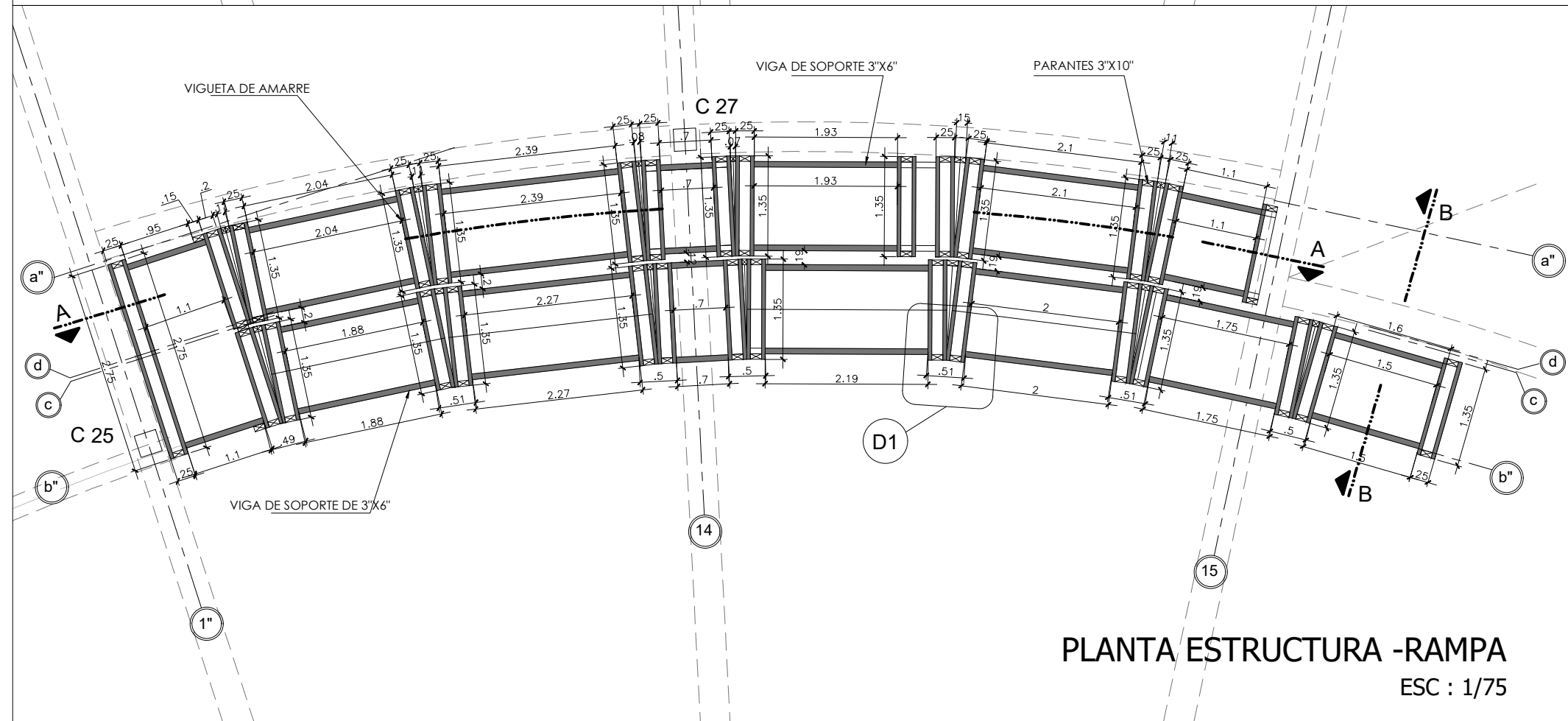

PLANTA ESTRUCTURA -RAMPA  
ESC : 1/75

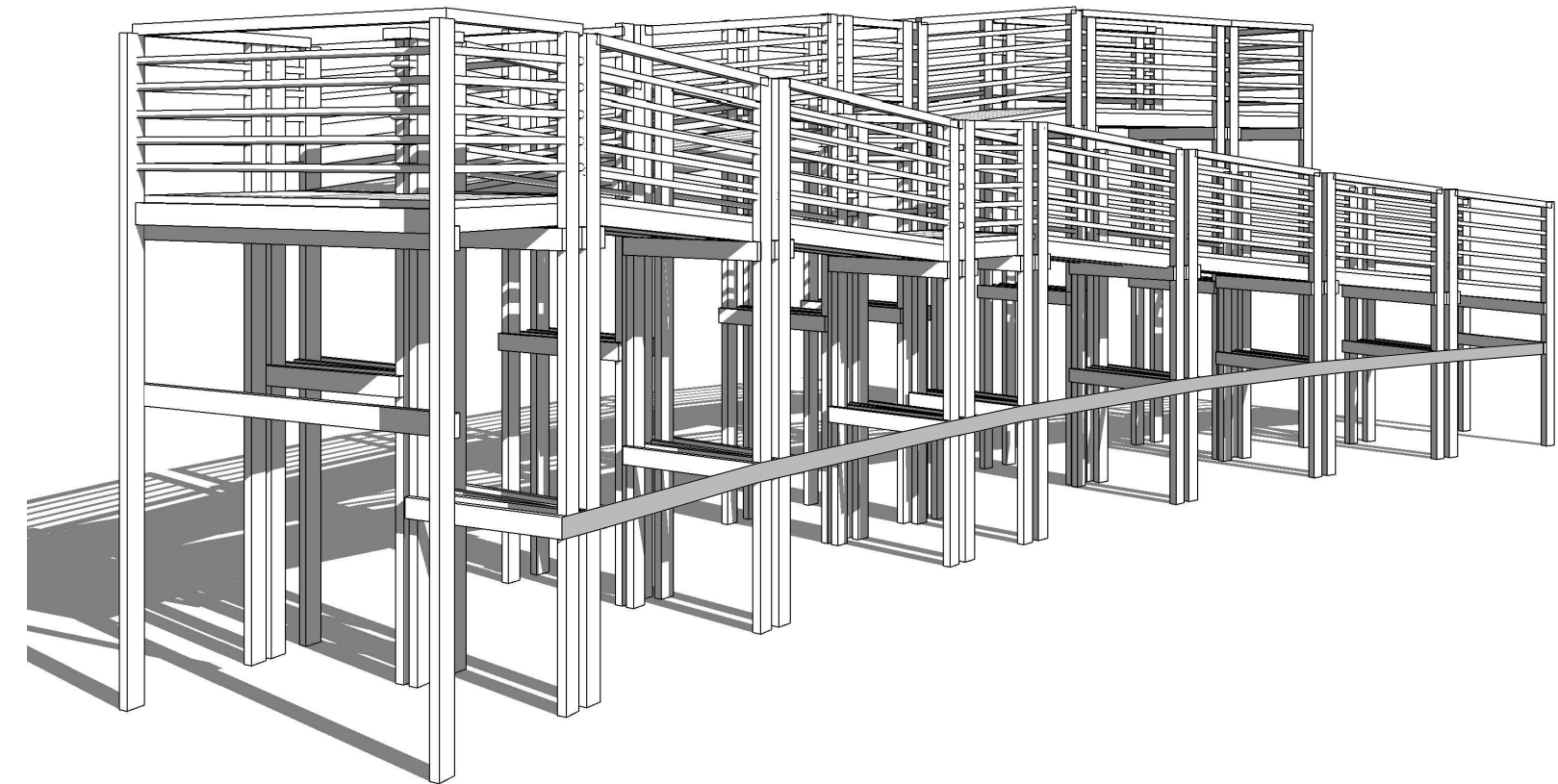

VISTA PERSPECTIVA  
ESTRUCTURAL

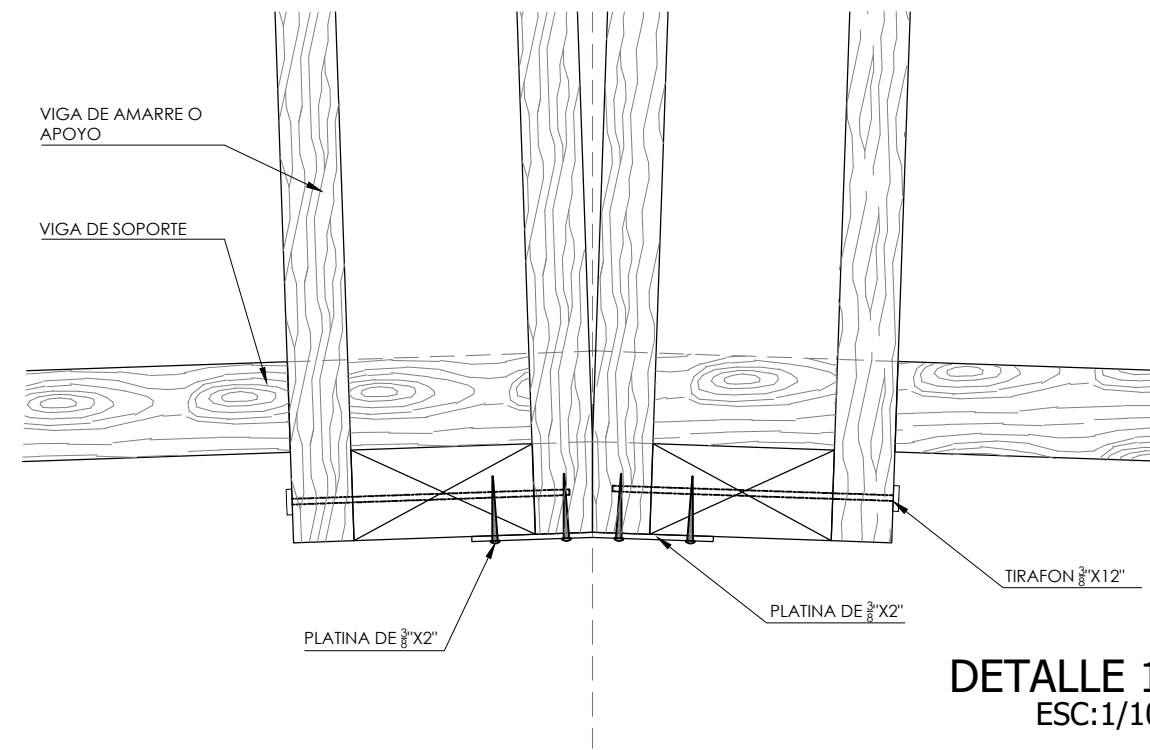

DETALLE 1  
ESC:1/10

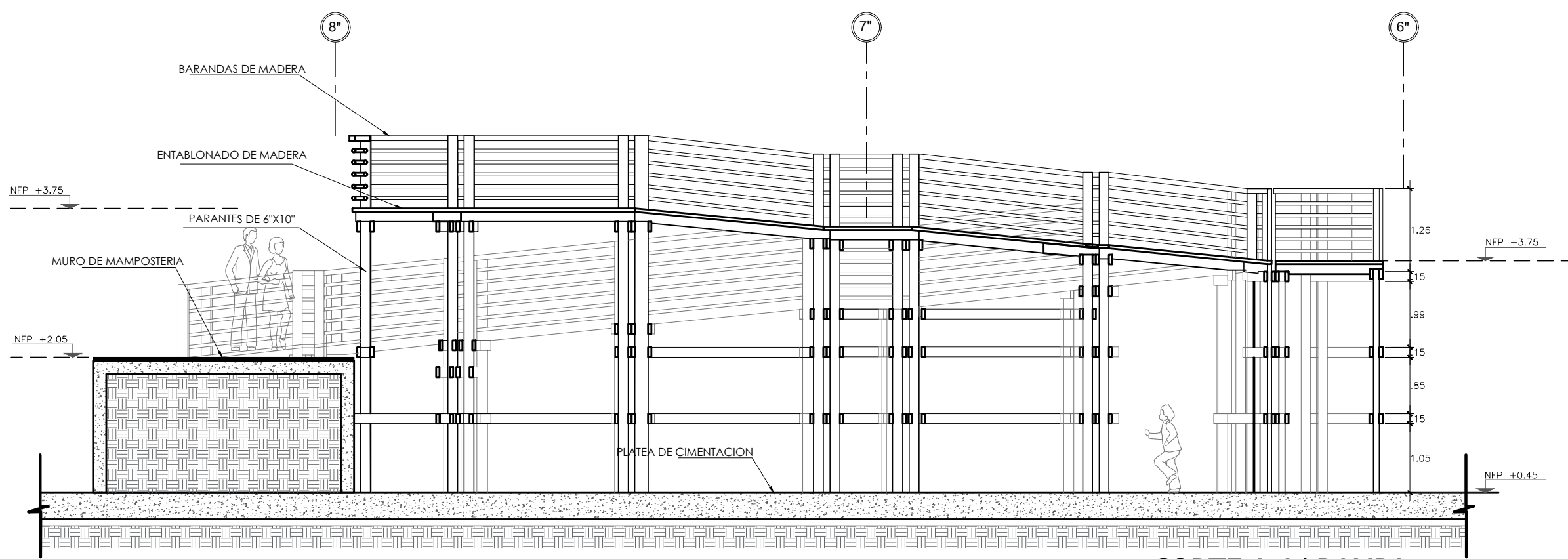

CORTE A-A/ RAMPA  
ESC : 1/75

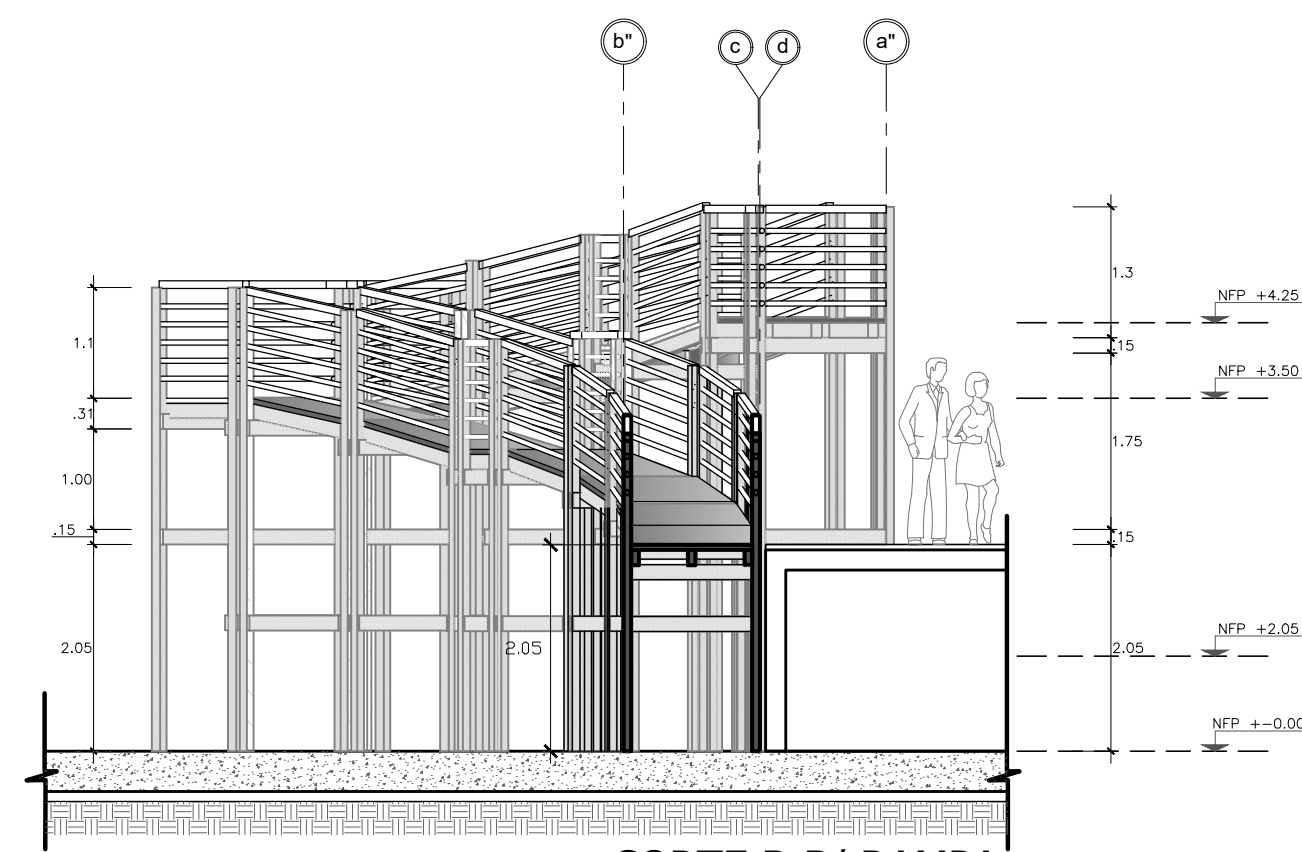

CORTE B-B/ RAMPA  
ESC : 1/25



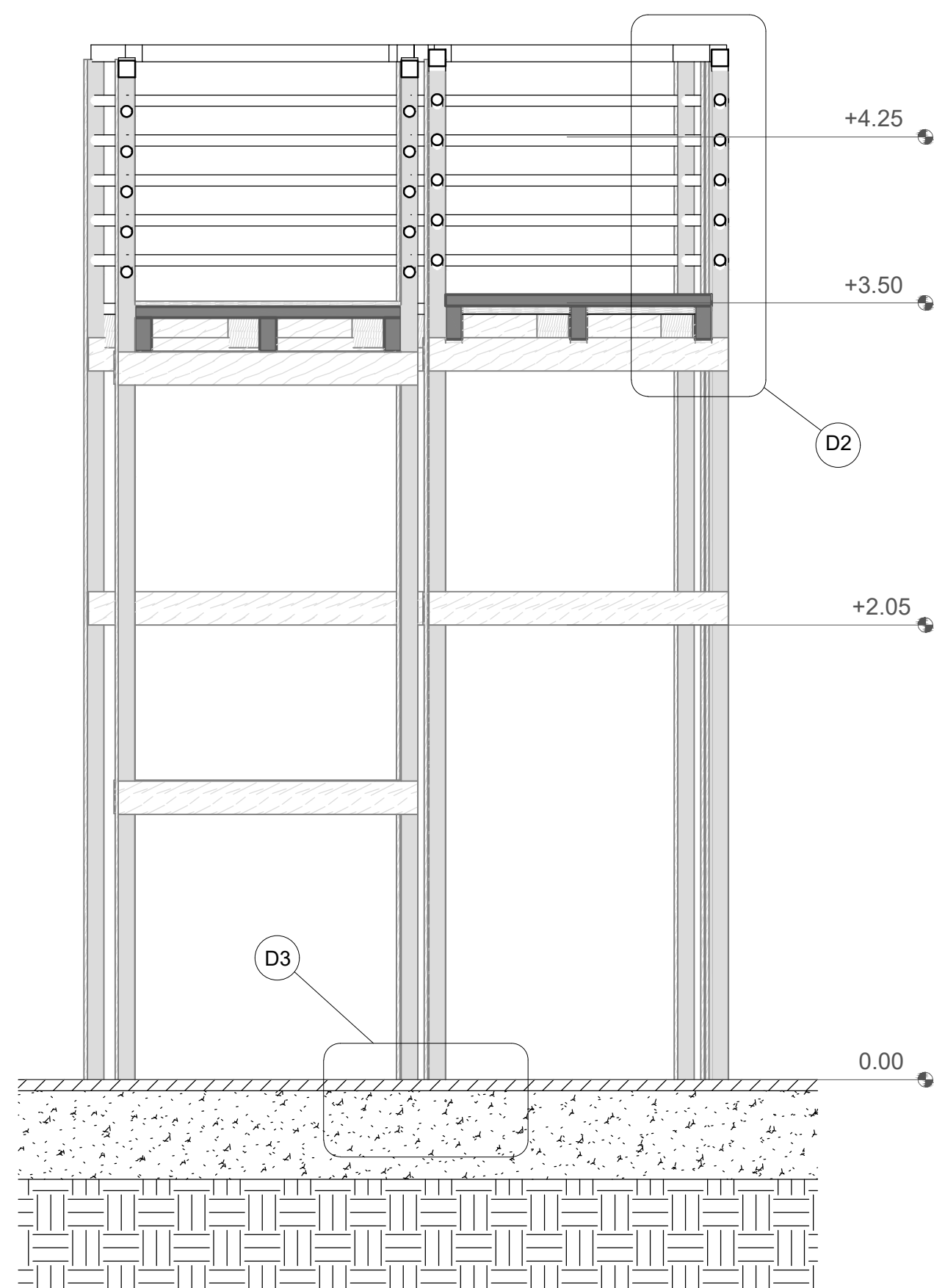

PLANTA PASARELA MIRADOR  
ESC : 1/25

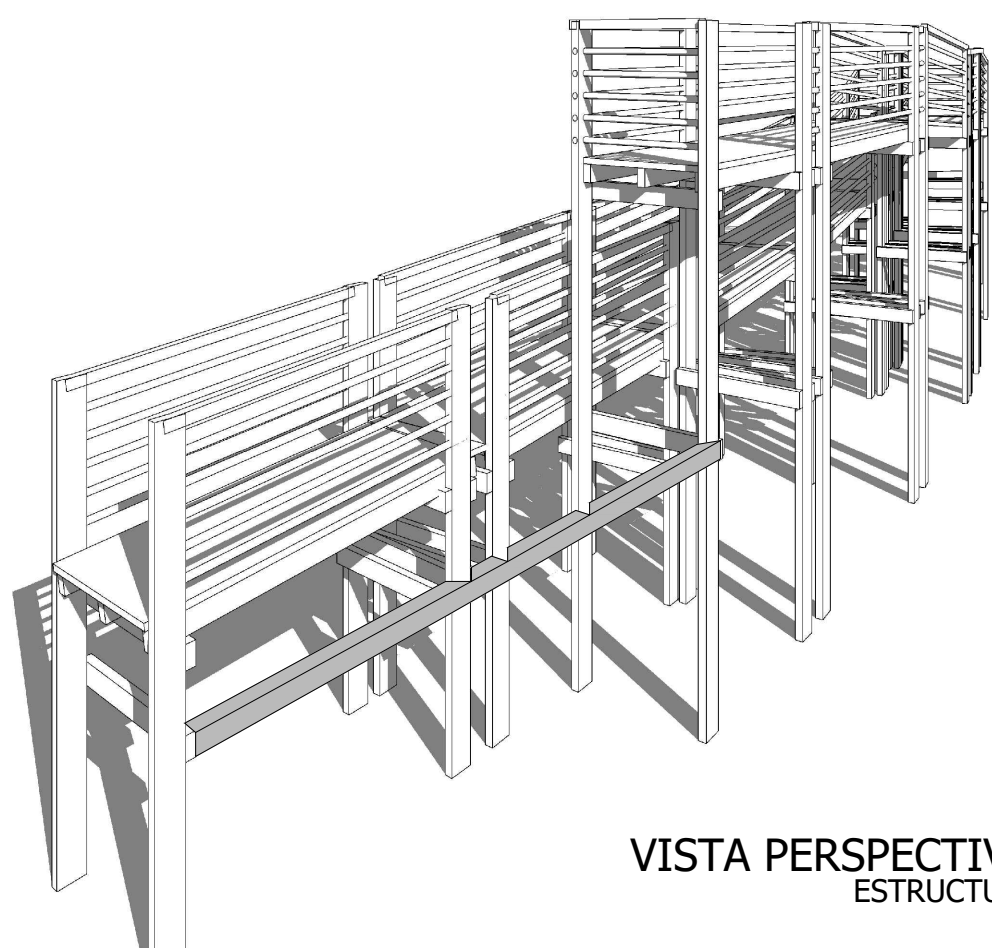

VISTA PERSPECTIVA  
ESTRUCTURA

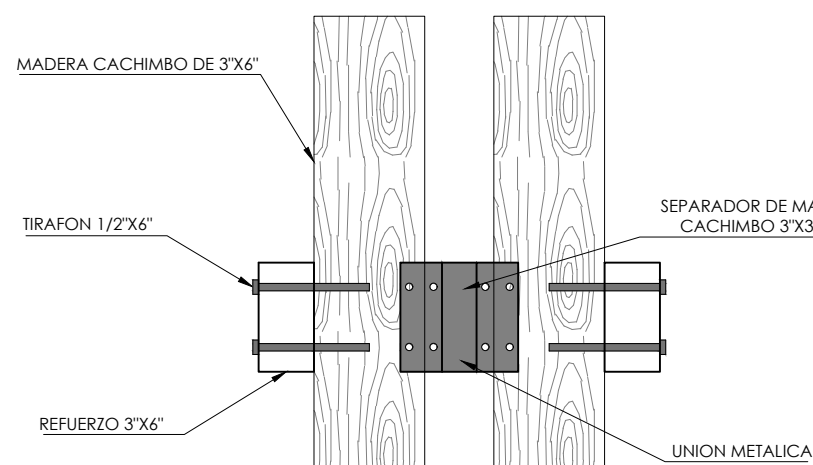

DETALLE 7  
ESC:1/10

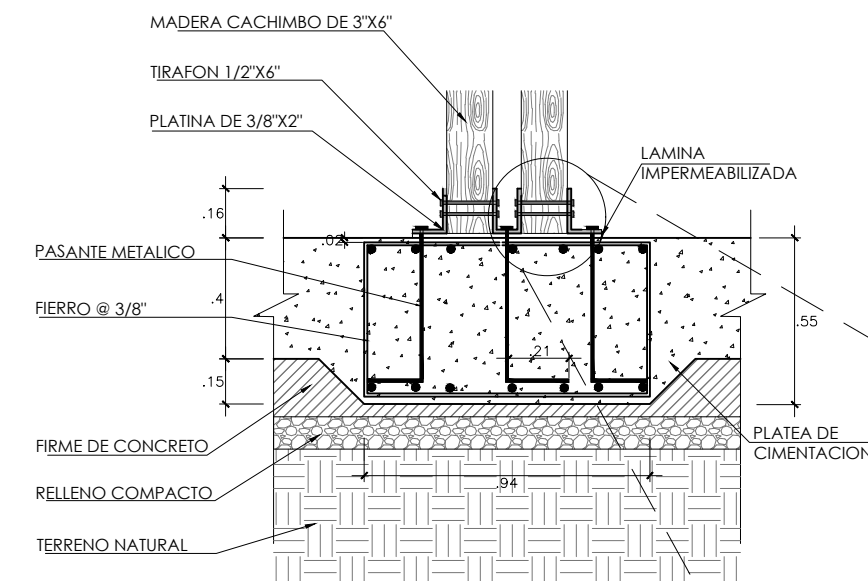

DETALLE 3  
ESC:1/10

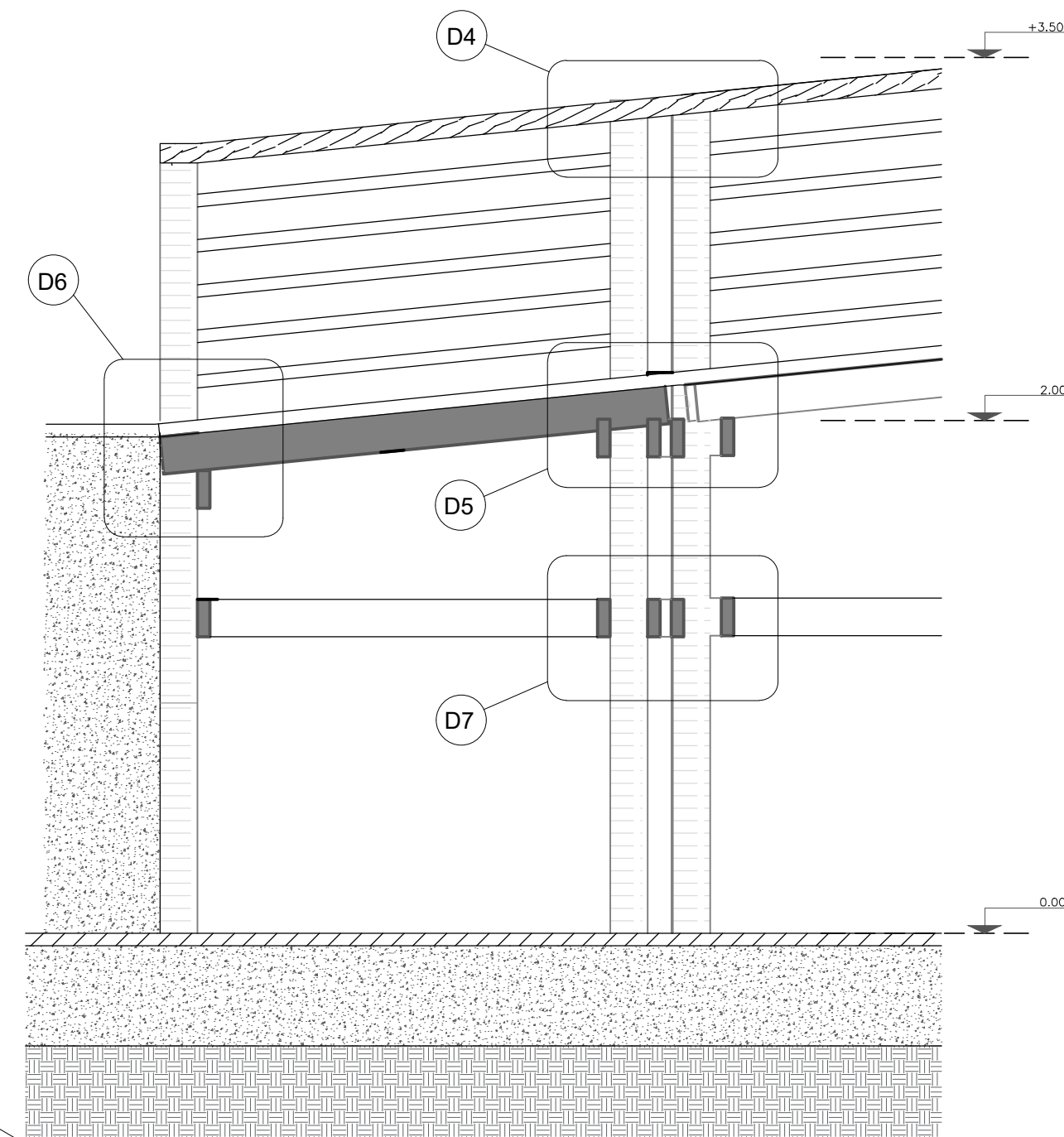

PLANTA PASARELA MIRADOR  
ESC : 1/25

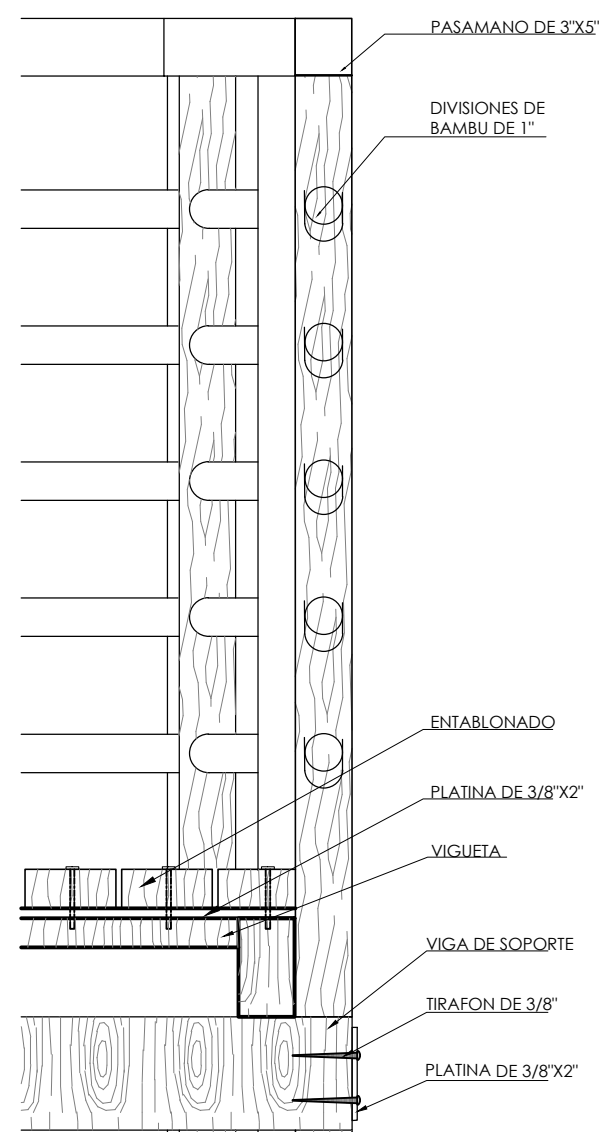

DETALLE 2  
ESC:1/10

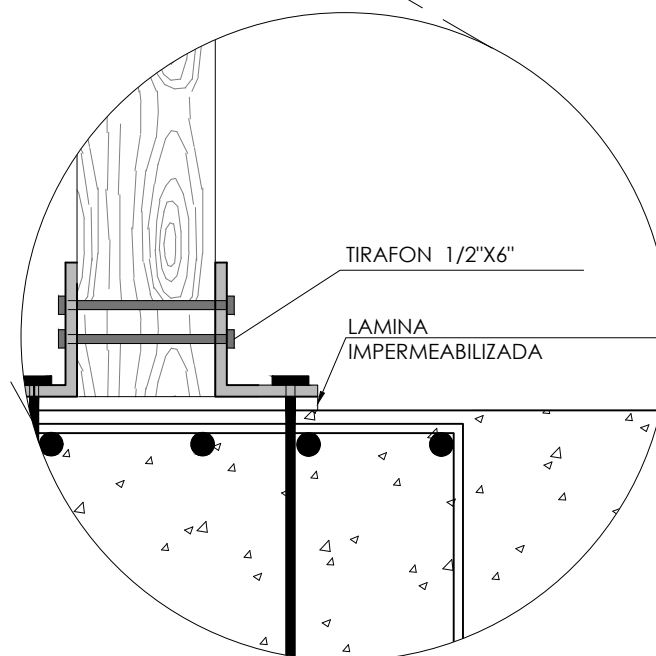

DETALLE 4  
ESC:1/10

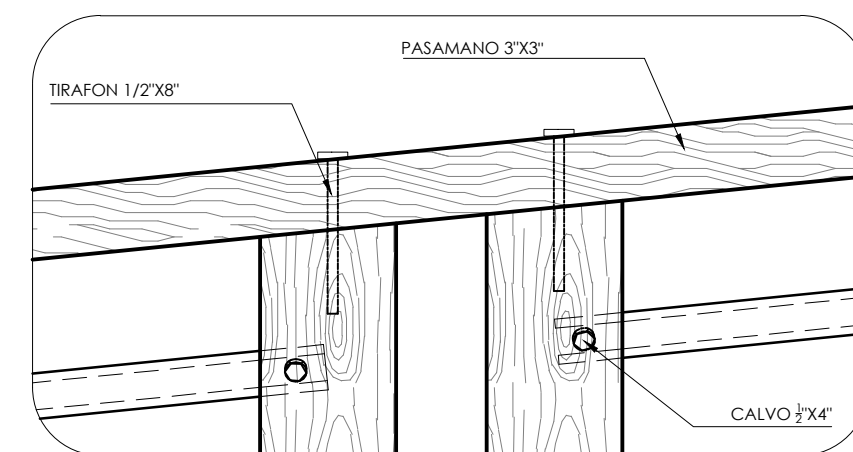

DETALLE 5  
ESC:1/10

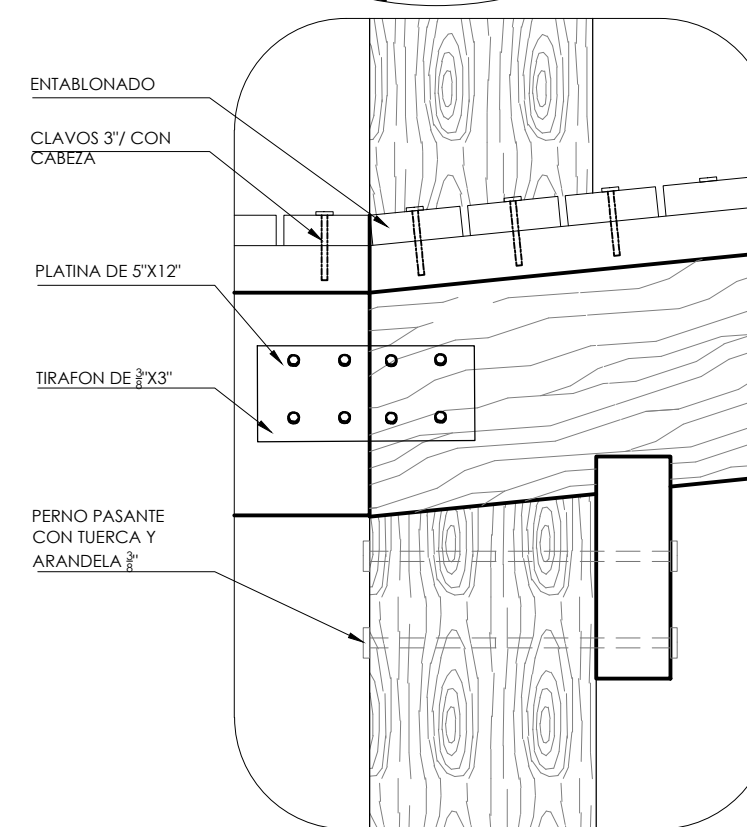

DETALLE 6  
ESC:1/10

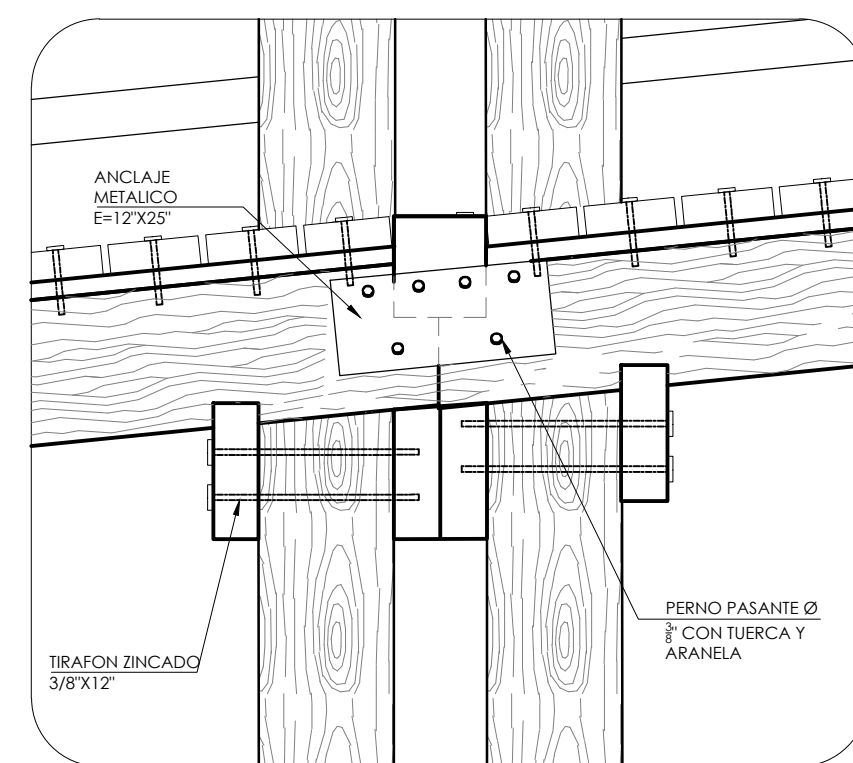

DETALLE 7  
ESC:1/10



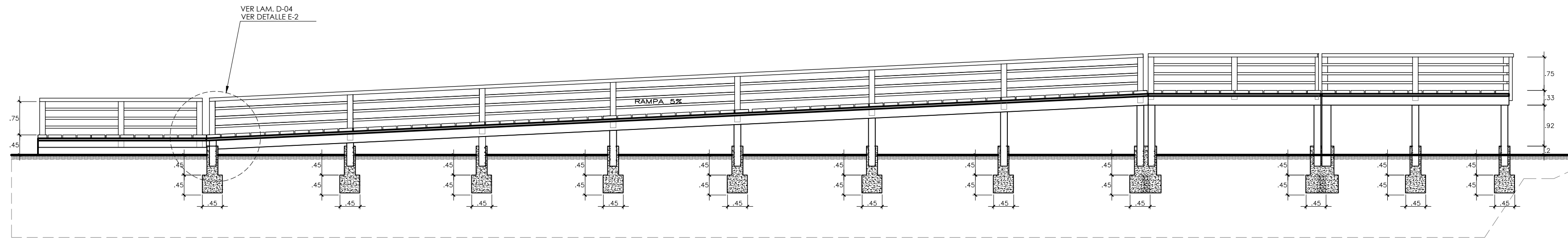

CORTE ESCALERA A-A  
ESC : 1/75

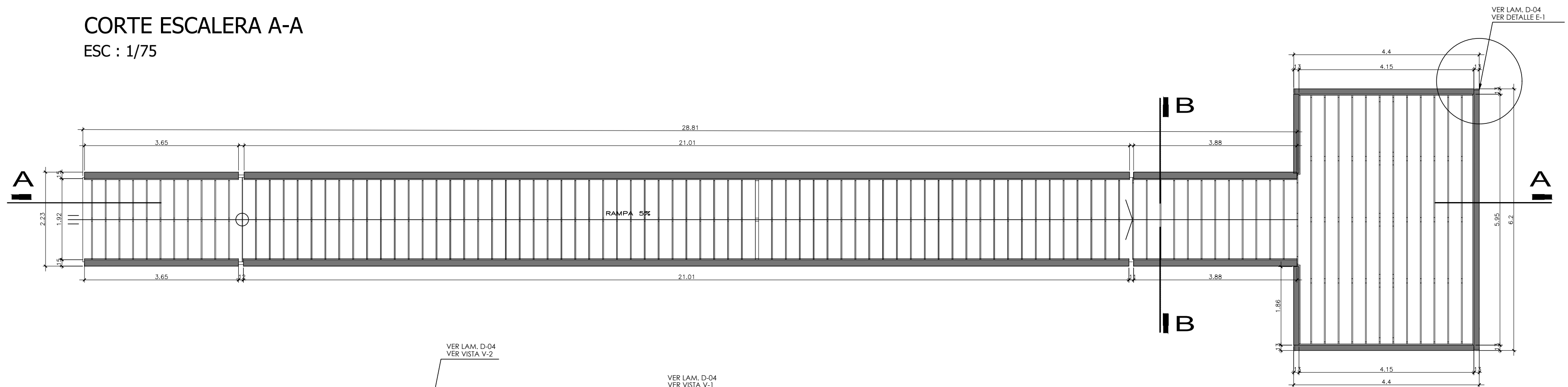

PLANTA ESCALERA  
ESC : 1/75

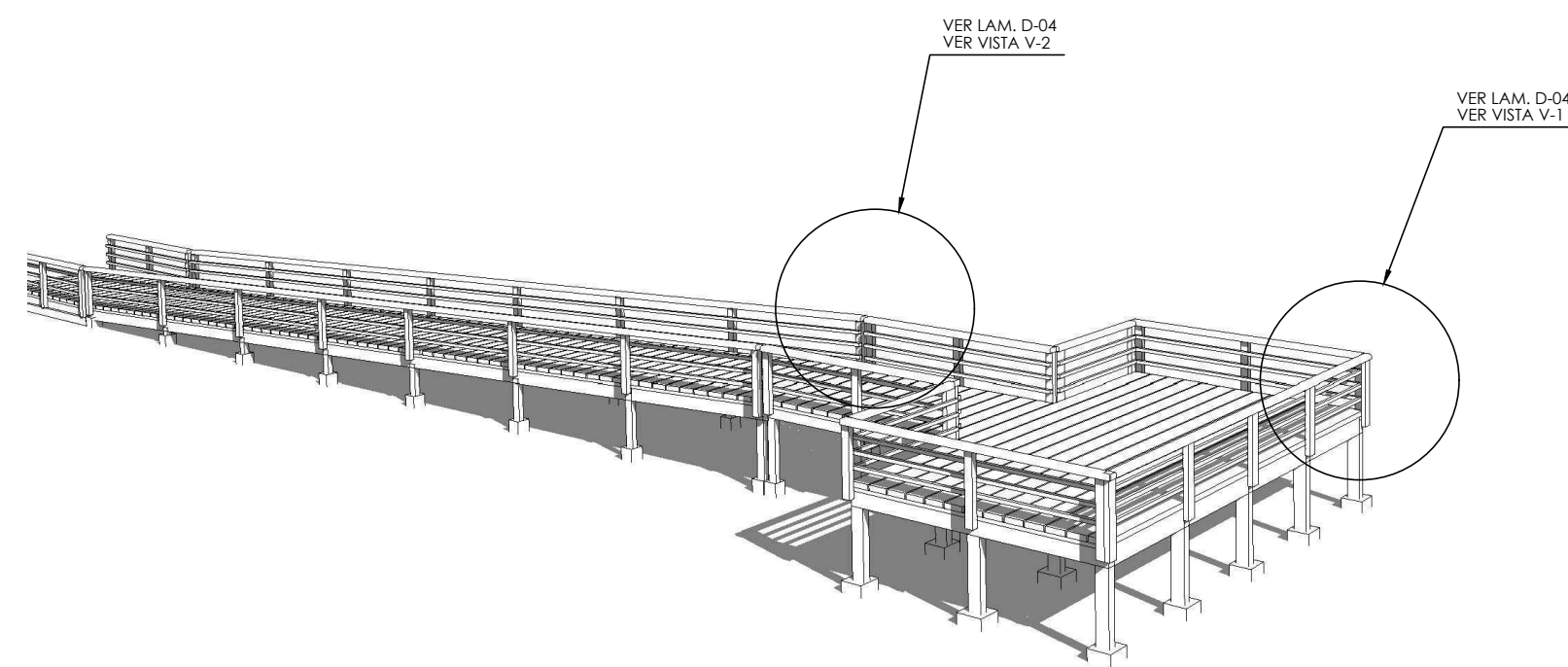

VISTA PERSPECTIVA  
ESTRUCTURA

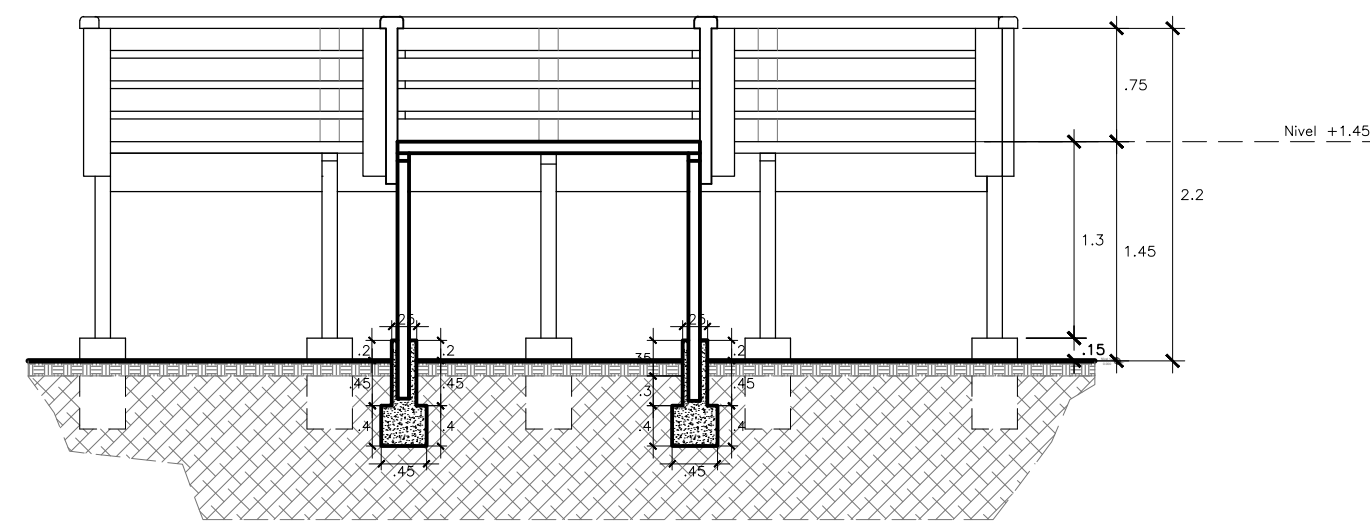

CORTE B-B  
ESC : 1/50



ISOMETRIA



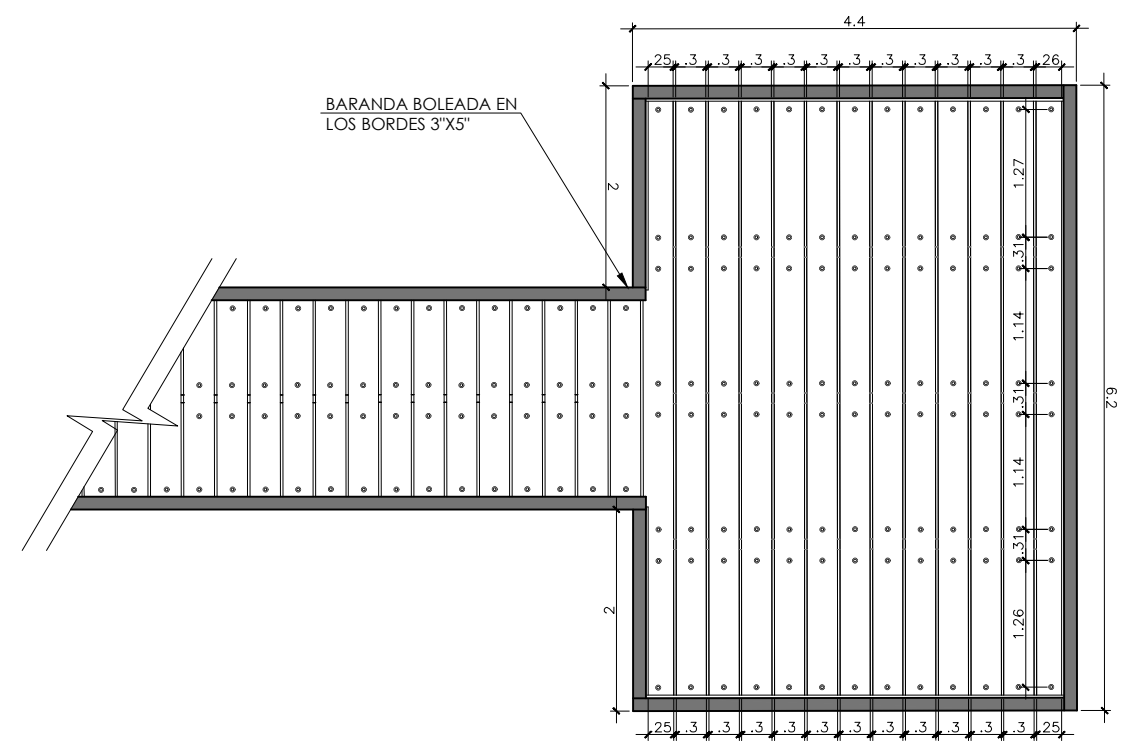

PLANTA PASARELA - MIRADOR- C 03  
ESC : 1/75

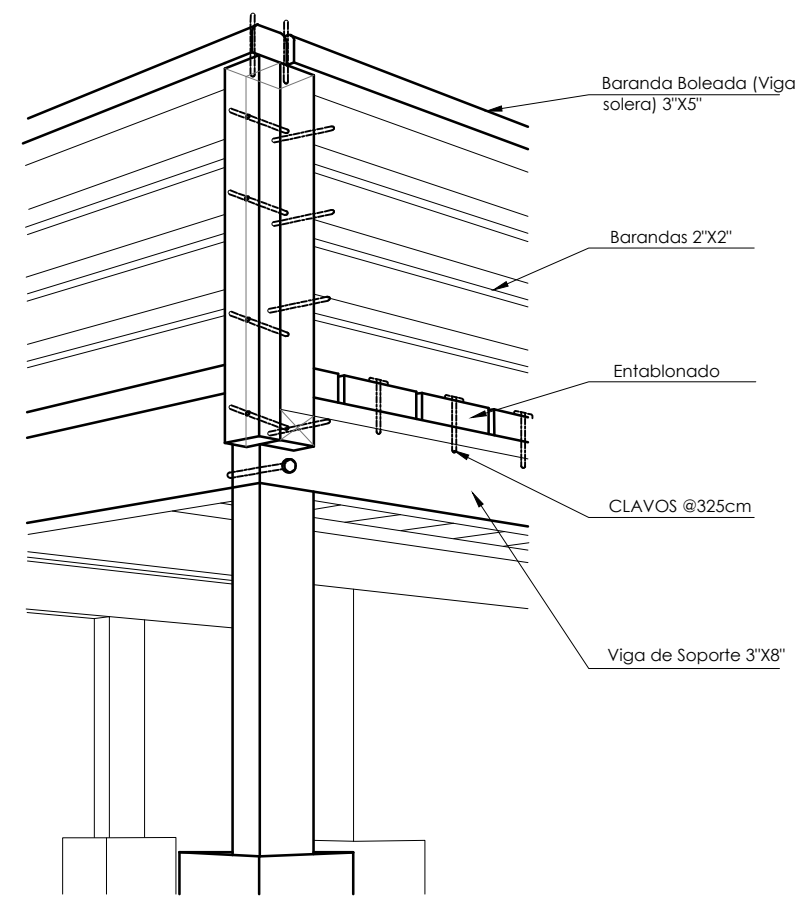

VISTA ISOMÉTRICA  
VISTA V-1

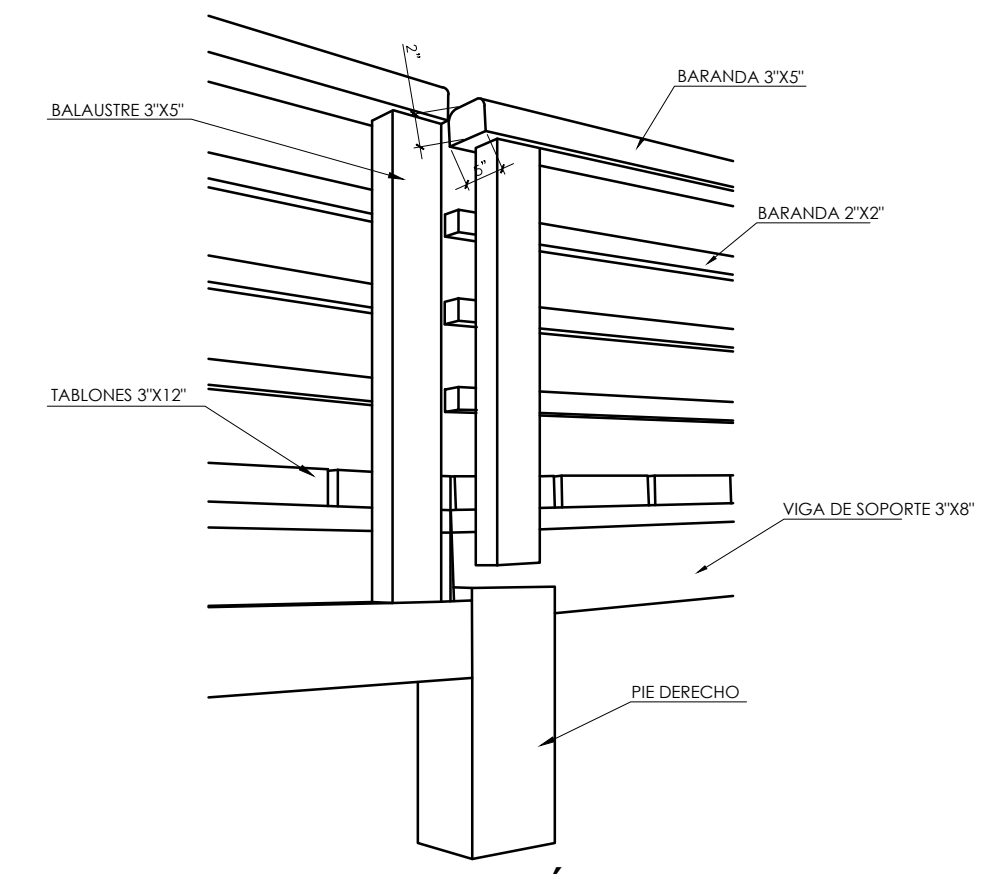

VISTA ISOMÉTRICA  
VISTA V-2

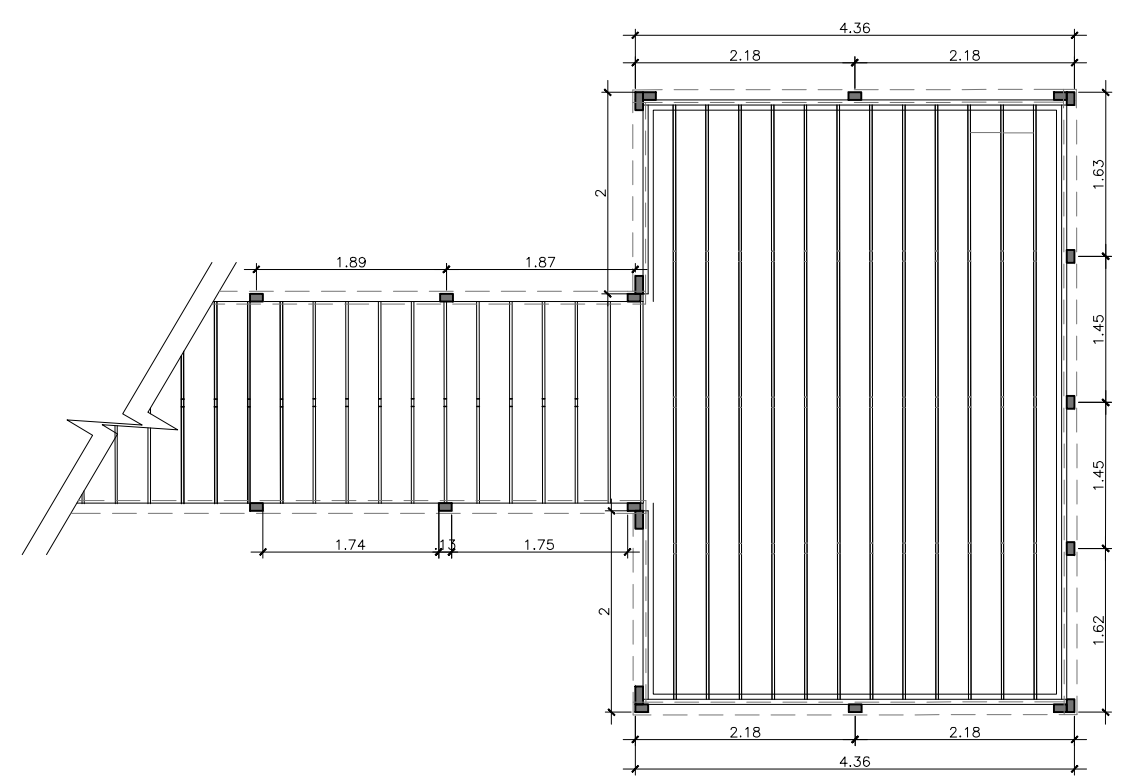

PLANTA PASARELA - MIRADOR- C 02  
ESC : 1/75

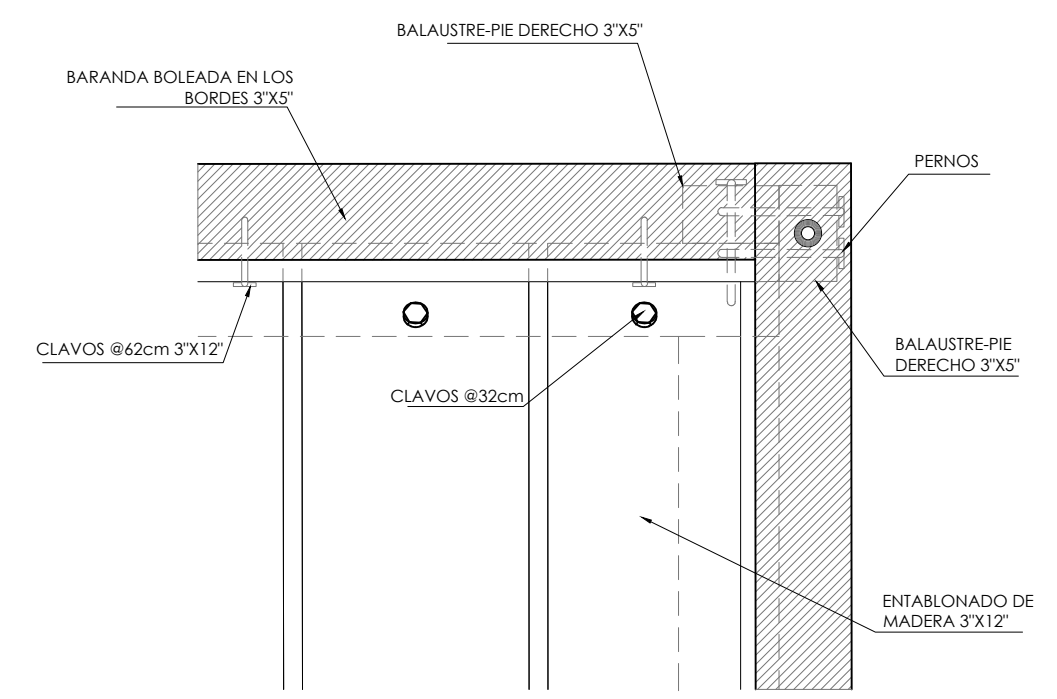

DETALLE E-1  
ESC:1/10

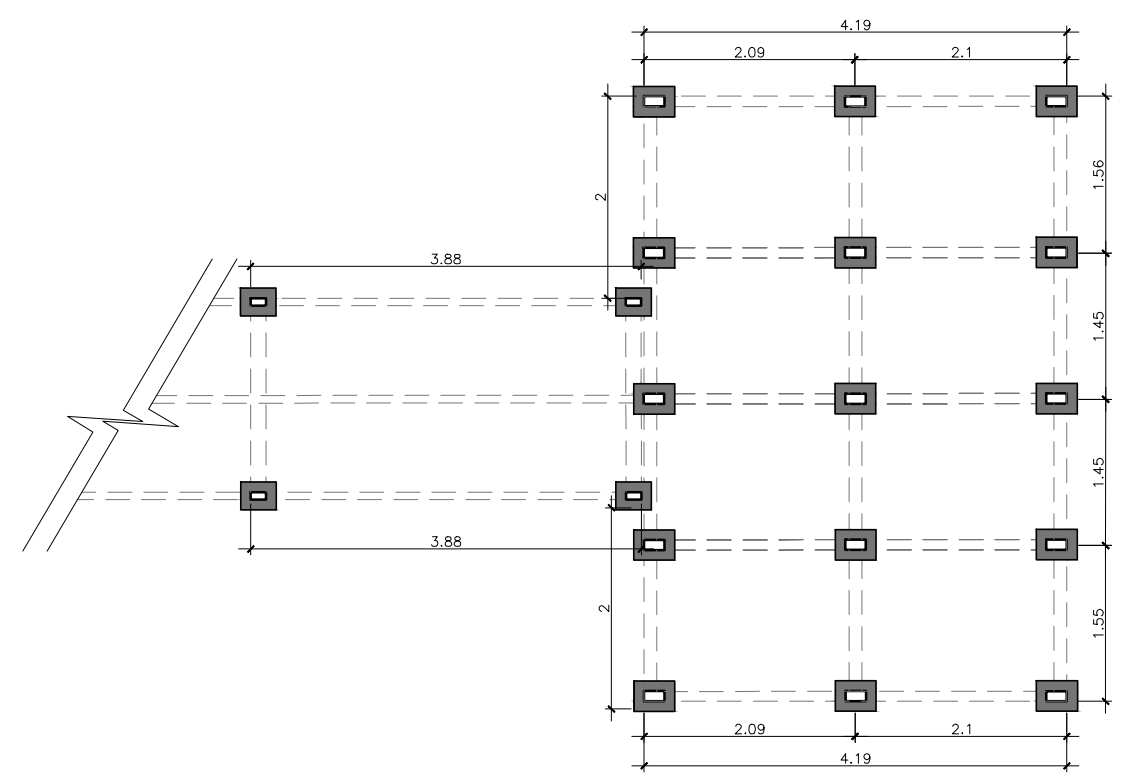

PLANTA PASARELA - MIRADOR- C 01  
ESC : 1/75

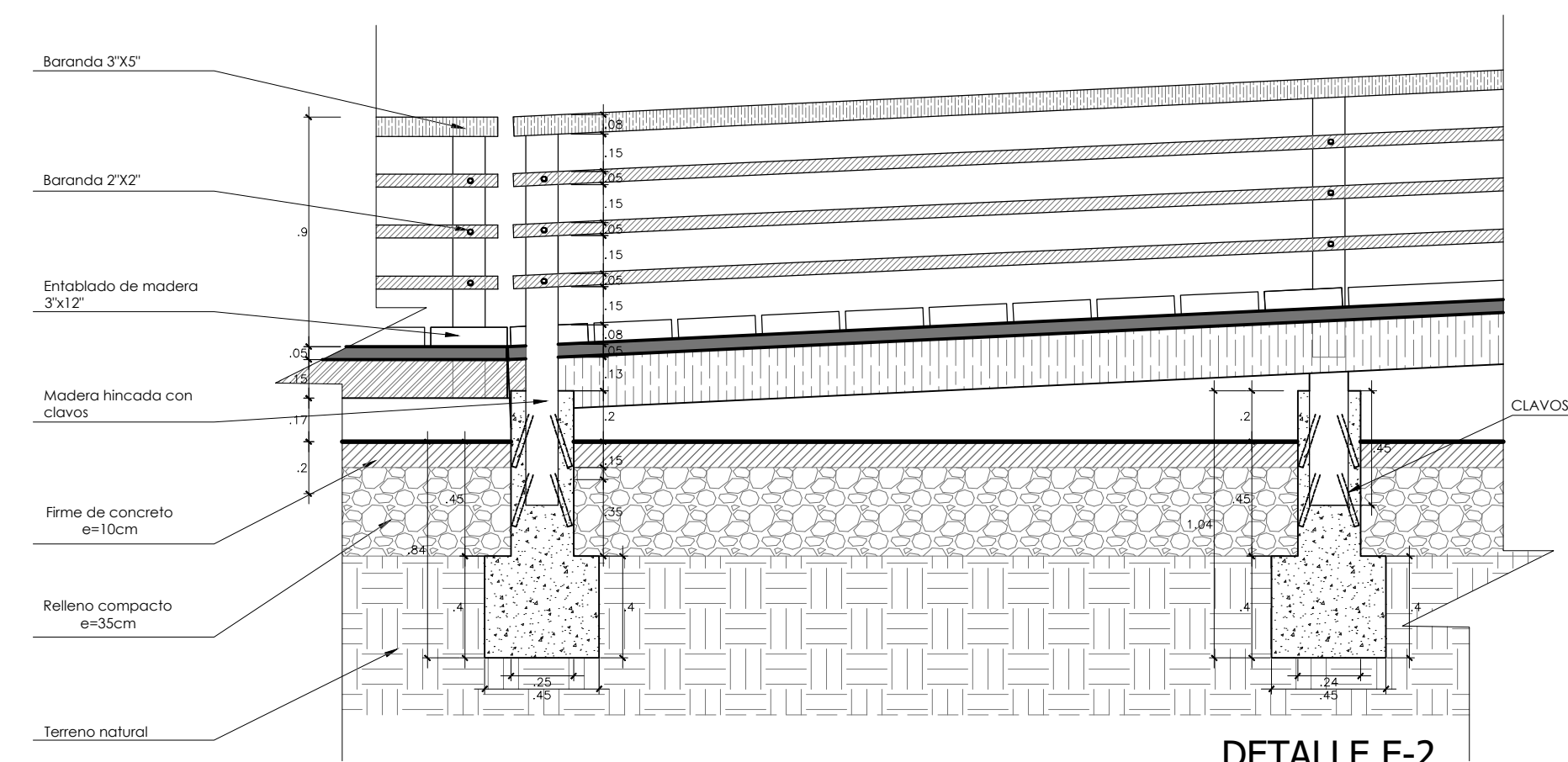

DETALLE E-2  
ESC:1/25